

Touch Type Counter/Timer

DIN W72×H36mm, W48×H48mm, W72×H72mm Counter/Timer

Features

- Selectable Counter or Timer function
- Multi-functional Counter/Timer (Includes 829,728 functions)
- Prescale function
- High speed counting of 10kcps
- Batch counter function for CT6, CT6-2P only
- Selectable Voltage input (PNP) or No voltage input (NPN)
- Able to set ON/OFF time individually in Flicker (FLK) mode
- Key Lock function



⚠ Please read "Caution for your safety" in operation manual before using.



Ordering information

CT	6	S	-	2P	
					I Indicator
					Single preset
				*	2P Dual preset
					Y DIN W72×H36mm
					S DIN W48×H48mm
					DIN W72×H72mm
					4 9999(Digit)
					6 99999(Digit)
					CT Counter/Timer

*When using dual preset as a timer, setting time is limited to one time.

Specifications

Model	Single preset	CT6Y	CT4S	CT6S	CT6
	Dual preset	CT6Y-2P	CT4S-2P	CT6S-2P	CT6-2P
	Indicator	CT6Y-I		CT6S-I	CT6-I
Digit		6	4	6	6
Digit size		PV:W4.5×H10mm SV:W3.5×H7mm	PV:W7×H11mm SV:W5×H8mm	PV:W4.5×H10mm SV:W3.5×H7mm	PV:W7×H13mm SV:W5×H9mm
Power supply	AC	100-240VAC 50/60Hz			
	AC/DC	24-60VAC 50/60Hz, 24-60VDC			24VAC 50/60Hz, 24-60VDC
Allowable voltage range		90 ~ 110% of rated voltage (AC power)			
Power consumption	AC	Approx. 7VA (240VAC 50/60Hz)			
	AC/DC	Approx. 7VA (24VAC 50/60Hz) Approx. 4W (24VDC)			
Counting speed of INA, INB		Selectable 1 / 30 / 1k / 5k / 10kcps			
	Counter	Reset input : Selectable 1ms or 2ms			
Min. input signal width	Timer	INA, INHIBIT, RESET : Selectable 1ms or 20ms			INA, RESET, INHIBIT, BATCH RESET (Except CT6-I) : Selectable 1ms or 20ms
		Selectable voltage input or No-voltage input [Voltage input] Input impedance : 5.4kΩ, "H" level : 5-30VDC, "L" level : 0-2VDC [No-voltage input] Short-circuit impedance : Max. 1kΩ, Residual voltage : Max. 2VDC, Open-circuit impedance : Min. 100kΩ			
One-shot output		10 / 50 / 100 / 200 / 500 / 1000 / 2000 / 5000ms			
Control output	Con-tact	Type	Single preset type : SPDT(1c) Dual preset type : SPST(1a) for first output SPDT(1c) for second output	Single preset type : SPDT(1c), Dual preset type : SPST(1a) for first/second output	Single preset type : SPDT(1c) Dual preset type : SPST(1a) for first output SPDT(1c) for second output
		Capacity	NO contact : 250VAC 3A resistive load, NC contact : 250VAC 2A at resistive load		
	Solid-state	Type	Single preset type : 1 NPN open collector Dual preset type : 1 NPN open collector		Single preset type : 2 NPN open collectors Dual preset type : 3 NPN open collectors
		Capacity	Max. 30VDC, Max. 100mA		

(A) Counter

(B) Timer

(C) Temp. controller

(D) Power controller

(E) Panel meter

(F) Tacho/Speed/Pulse meter

(G) Display unit

(H) Sensor controller

(I) Switching power supply

(J) Proximity sensor

(K) Photo electric sensor

(L) Pressure sensor

(M) Rotary encoder

(N) Stepping motor & Driver & Controller

(O) Graphic panel

(P) Production stoppage models & replacement

CTY/CTS/CT Series

Specifications

Memory protection	10 years (When using non-volatile semiconductor memory)				
External power	12VDC $\pm 10\%$, Max. 100mA				
Timer accuracy	Repeat error	Power ON start : Max. $\pm 0.01\% \pm 0.05\text{sec}$ Signal start : Max. $\pm 0.01\% \pm 0.03\text{sec}$			
	Set error				
	Voltage error				
	Temperature error				
Insulation resistance	Min. 100M Ω (at 500VDC mega)				
Dielectric strength	2000VAC 50/60Hz for 1 minute				
Noise strength	$\pm 2\text{kV}$ the square wave noise (pulse width:1 μs) by the noise simulator				
Vibration	Mechanical	0.75mm amplitude at frequency of 10 ~ 55Hz in each of X, Y, Z directions for 1 hour			
	Malfunction	0.5mm amplitude at frequency of 10 ~ 55Hz in each of X, Y, Z directions for 10 minutes			
Shock	Mechanical	300m/s ² (Approx. 30G) in X,Y,Z directions for 3 times			
	Malfunction	100m/s ² (Approx. 10G) in X,Y,Z directions for 3 times			
Relay life cycle	Mechanical	Min. 10,000,000 times			
	Electrical	Min. 100,000 times (NO : 250VAC 3A at resistive load, NC : 250VAC 2A at resistive load)			
Protection	IP65 (Front panel only)				
Ambient temperature	-10 ~ +55 $^{\circ}\text{C}$ (at non-freezing status)				
Storage temperature	-25 ~ +65 $^{\circ}\text{C}$ (at non-freezing status)				
Ambient humidity	35 ~ 85%RH				
Unit weight	AC power	CT6Y:Approx. 160g CT6Y-2P:Approx. 163g CT6Y-I:Approx. 127g	CT4S:Approx. 155g, CT4S-2P:Approx. 162g	CT6S:Approx. 155g CT6S-2P:Approx. 162g CT6S-I:Approx. 136g	CT6:Approx. 264g CT6-2P:Approx. 271g CT6-I:Approx. 244g
	AD/DC power	CT6Y:Approx. 164g CT6Y-2P:Approx. 167g CT6Y-I:Approx. 130g	CT4S:Approx. 152g CT4S-2P:Approx. 159g	CT6S:Approx. 152g CT6S-2P:Approx. 159g CT6S-I:Approx. 133g	CT6:Approx. 263g CT6-2P:Approx. 270g CT6-I:Approx. 243g
Approval	 (100-240VAC 50/60Hz), CE				

Connections

CT6Y

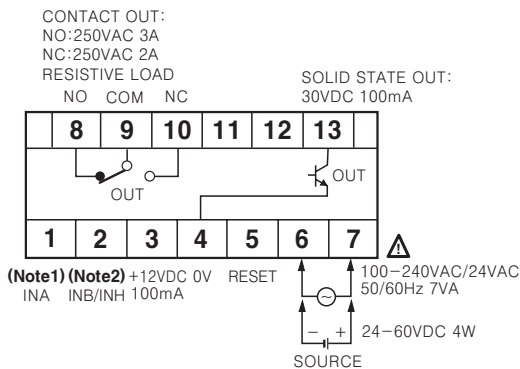

CT6Y-2P

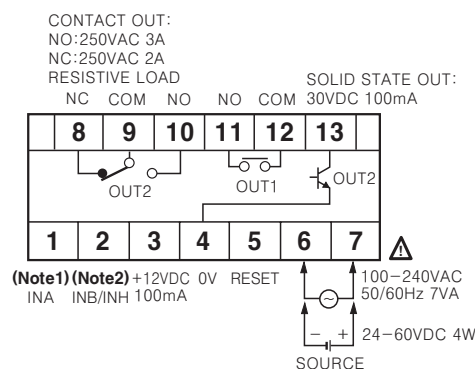

CT6Y-I

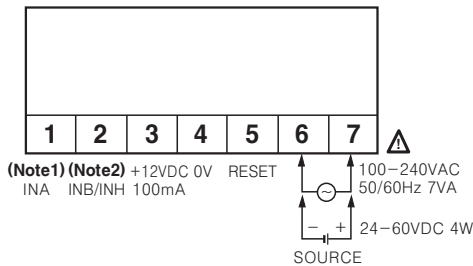

※ (Note1) INA terminal

- Operation of Counter : Operating as INA signal or INH signal
- Operation of Timer : Operating as "START"

※ (Note2) INB/INH terminal

- Operation of Counter : Operating as INB signal
 - Operation of Timer : Operating as INH signal
- If the signal is applied to INH terminal, the processing time is stopped. (Time hold)

※ Connection of relay contact input when voltage input (PNP) is selected

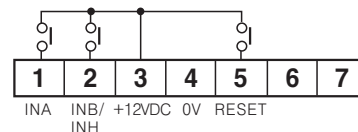

※ Connection of relay contact input when No-voltage input (NPN) is selected

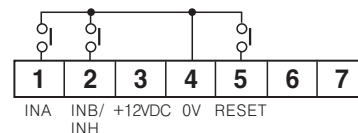

Touch Type Counter/Timer

◎CT4S, CT6S

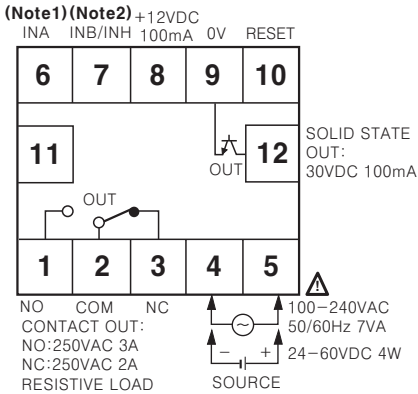

※(Note1) INA terminal

- Operation of Counter : Operating as INA signal or INH signal.
- Operation of Timer : Operating as "START".

※(Note2) INB/INH terminal

- Operation of Counter : Operating as INB signal
- Operation of Timer : Operating as INH signal
- If the signal is applied to INH terminal, the processing time is stopped. (Time hold)

◎CT4S-2P, CT6S-2P

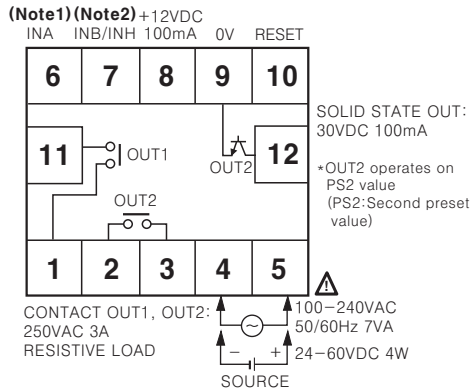

◎CT6S-I

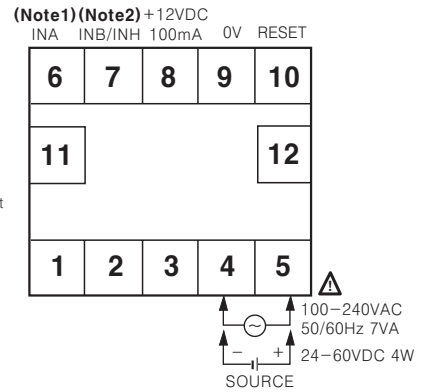

- Connection of relay contact input when voltage input (PNP) is selected

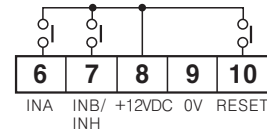

- Connection of relay contact input when No-voltage input (NPN) is selected

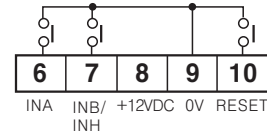

◎CT6

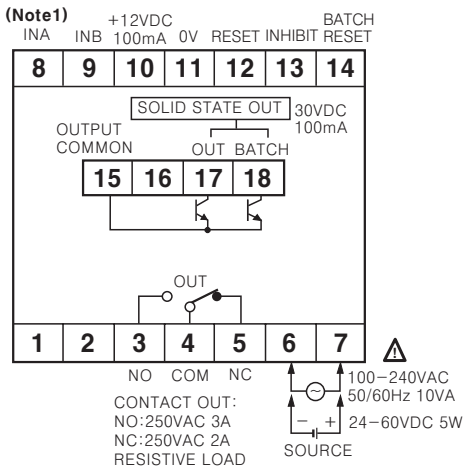

◎CT6-2P

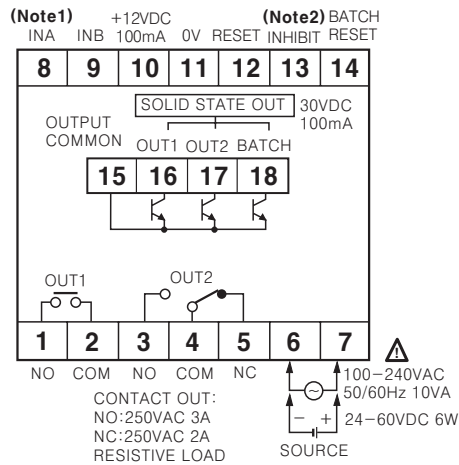

◎CT6-I

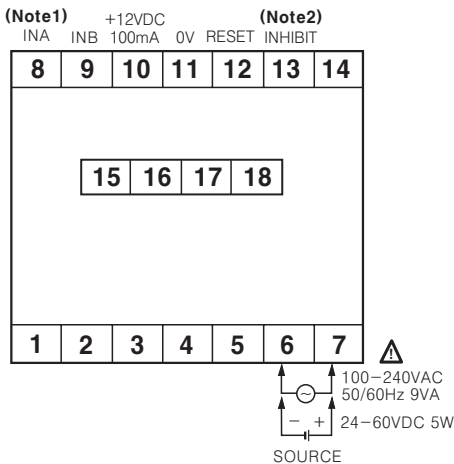

※(Note1) INA terminal

- Operation of Counter : Operating as INA signal or INH signal.
- Operation of Timer : Operating as "START"

※(Note2) INHIBIT signal

- If the signal is applied to INH terminal, the processing time is stopped. (Time hold)

- Solid state output is insulated from inner circuit by photocoupler. (Power supply : 5-30VDC Max.)

- Connection of relay contact input when voltage input (PNP) is selected

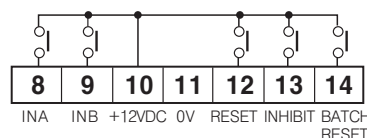

- Connection of relay contact input when No-voltage input (NPN) is selected

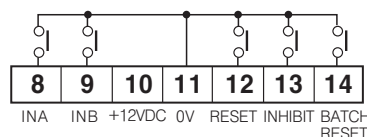

(A) Counter

(B) Timer

(C) Temp. controller

(D) Power controller

(E) Panel meter

(F) Tacho/Speed/Pulse meter

(G) Display unit

(H) Sensor controller

(I) Switching power supply

(J) Proximity sensor

(K) Photo electric sensor

(L) Pressure sensor

(M) Rotary encoder

(N) Stepping motor & Driver & Controller

(O) Graphic panel

(P) Production stoppage models & replacement

CTY/CTS/CT Series

Dimensions

CTY Series

CT6Y

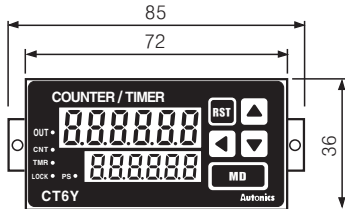
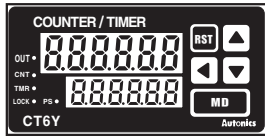

CT6Y-2P

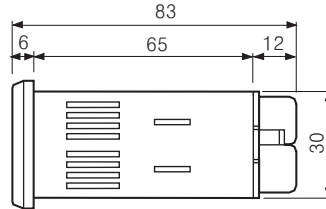
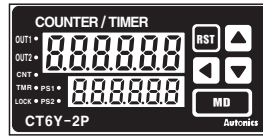

CT6Y-I

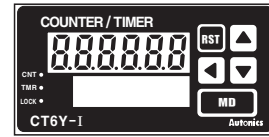

Panel cut-out

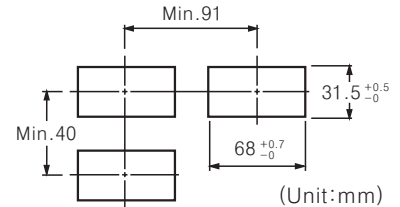

CTS Series

CT4S

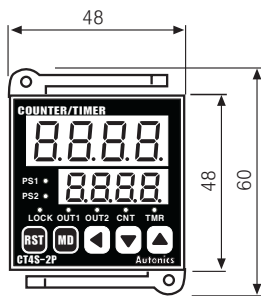

CT4S-2P

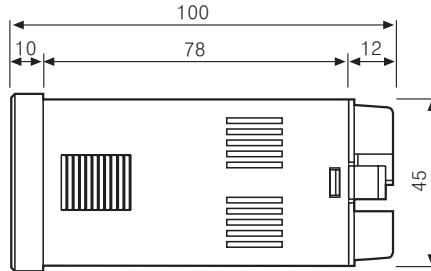

CT6S

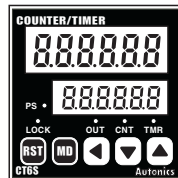

CT6S-2P



CT6S-I



Panel cut-out

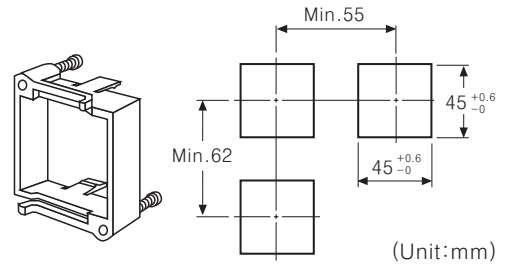

CT Series

CT6

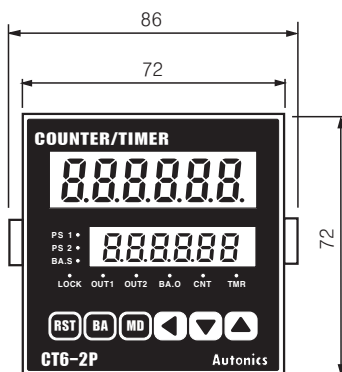

CT6-2P

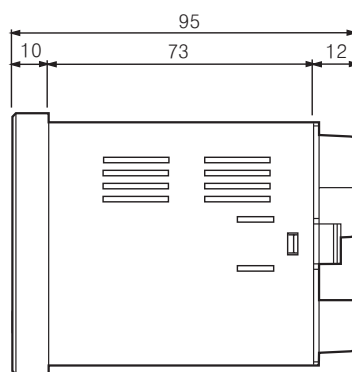
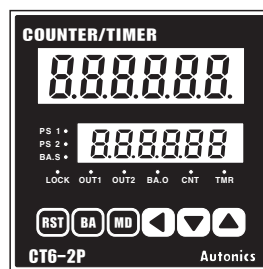

CT6-I

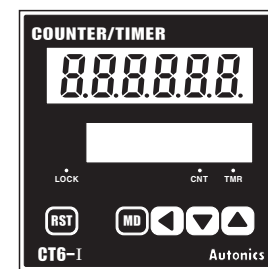

Panel cut-out

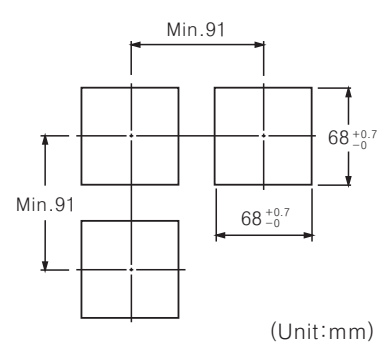

Touch Type Counter/Timer

Front panel identification

CTY series

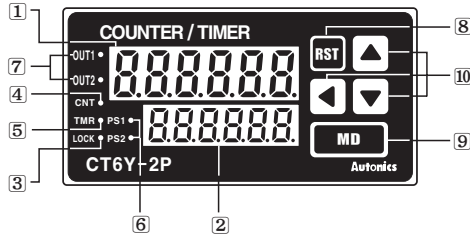

- 1 Display for process value (Red LED)
Count value (Counter) / Process time (Timer)
/ Setting symbols
LED height : 11mm for 4digit, 10mm for 6digit
- 2 Display for setting value (Yellow-Green LED)
Setting value (Counter) / Preset time (Timer) and
setting symbols.
LED height : 8mm for 4digit, 7mm for 6digit
- 3 LOCK : Key Lock indication
-Lock OFF : Light OFF
-Lock ON : Light ON

※ There is no 6, 7 LED in CT6Y-I, CT6S-I.

※ In CT4S, CT6S, CT6Y, PS2 will be changed to PS and OUT2 is OUT and there is no PS1, OUT1 LED.

CTS series

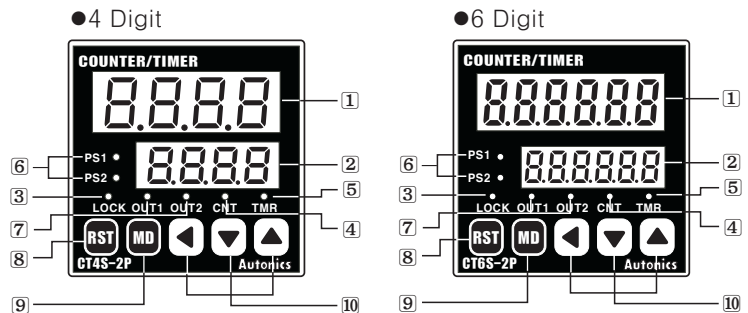

- 4 CNT : Indicates operation as a counter
- 5 TMR : Indicates operation as a timer
-LED flashes when timer operates
-LED turns on when the time stop operating
- 6 PS1, PS2 : Indicates that preset is being displayed
or changed.
- 7 OUT1, OUT2 : Indicating the operation of output
- 8 RST : Reset key
- 9 MD : Mode key
- 10 ◀, ▼, ▲ : Set key

CT Series

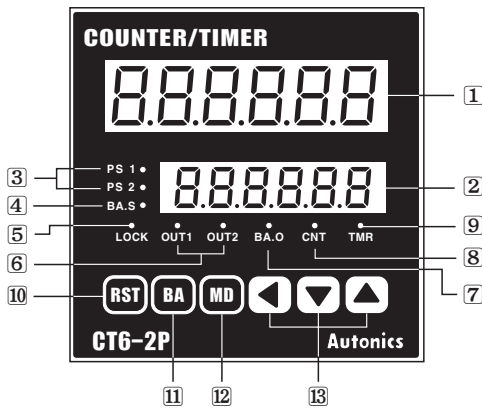

※ In CT6, PS2 will be changed to PS and OUT2 to OUT, since there is no PS1, OUT1 LED.

※ There are no PS1, PS2, BA.S, OUT1, OUT2, BA.O LED in CT6-I.

※ There is no BA key in CT6-I.

- 1 Display for process value (Red LED)
Count value (Counter) / Process time (Timer) / Setting symbols
LED height : 13mm
- 2 Display for setting value (Yellow-Green LED)
Setting value (Counter) / Setting time (Timer) and setting symbols
LED height : 9mm
- 3 PS1, PS2 : Indicates which setting value (Single, Dual) is being
displayed or changed
- 4 BA.S : Set a batch setting value and display the change
-Use BA.S : Turn ON
-Not use BA.S : Turn OFF
- 5 LOCK : Display Key Lock operation
-Use Lock : Turn ON
-Not use Lock : Turn OFF
- 6 OUT1, OUT2 : Preset the operation of output (Single & Dual)
- 7 BA.O : Indicates operation as BATCH output
- 8 CNT : Indicates operation as counter
- 9 TMR : Indicates operation as timer
-LED flashes when the timer is operating
-LED turns on when the timer stops operating
- 10 RST : Reset key
- 11 BA : Batch key
- 12 MD : Mode key
- 13 ◀, ▼, ▲ : Set key

(A) Counter

(B) Timer

(C) Temp. controller

(D) Power controller

(E) Panel meter

(F) Tacho/Speed/Pulse meter

(G) Display unit

(H) Sensor controller

(I) Switching power supply

(J) Proximity sensor

(K) Photo electric sensor

(L) Pressure sensor

(M) Rotary encoder

(N) Stepping motor & Driver & Controller

(O) Graphic panel

(P) Production stoppage models & replacement

CTY/CTS/CT Series

Input connections

⊙No-voltage input(NPN)

- Solid-state input(Standard sensor : NPN output type sensor)

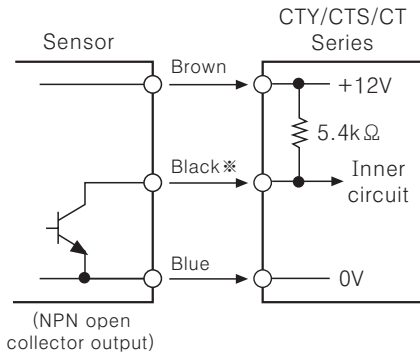
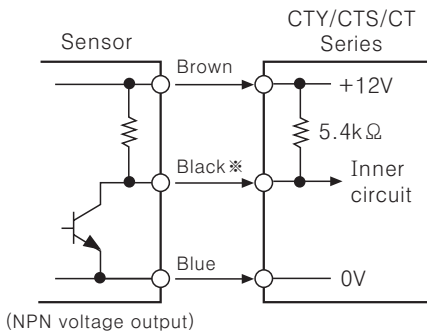

- Contact input

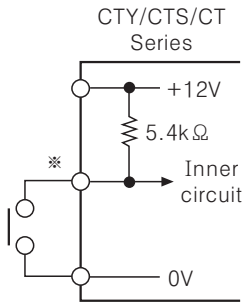

※Please select the counting speed as 1cps or 30cps when it is used for counter.

※INPUT circuit of INA, INB, INH(INHIBIT), BATCH RESET, RESET are the same.
 ※INA is input terminal when it is used for Counter and can be START signal input terminal when it is used for Timer.

⊙Voltage input(PNP)

- Solid-state input(Standard sensor : PNP output type sensor)

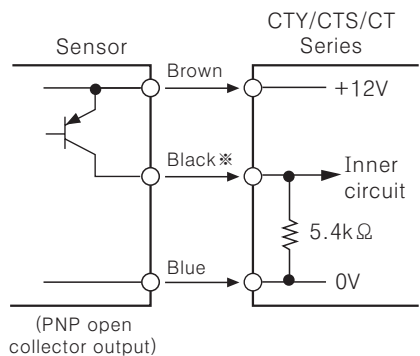
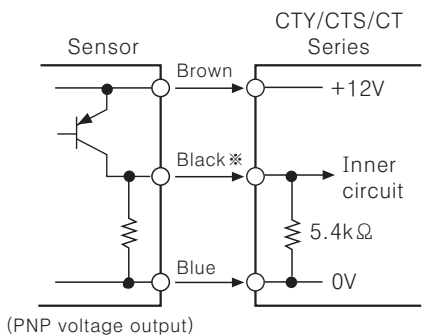

- Contact input

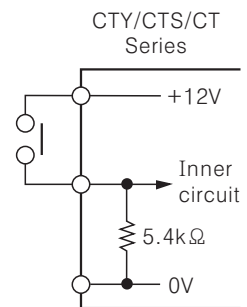

※Please select the counting speed as 1cps or 30cps when it is used for counter.

※INPUT circuit of INA, INB, INH(INHIBIT), BATCH RESET, RESET are the same.
 ※INA is input terminal when it is used for Counter and can be START signal input terminal when it is used for Timer.

Input logic selection

⊙CTY/CTS Series

1. The power must be cut off.
2. Detach the case from the body.

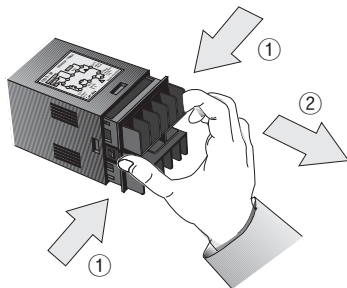

*Case detachment
 Squeeze toward ① and pull toward ② as shown in picture.

⚠ Please check if the power is cut off.

3. Select input logic by using input logic switch inside Counter/Timer.

- Select No-voltage input(NPN)
- Select voltage input(PNP)

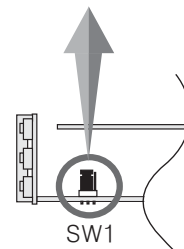
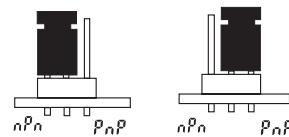

< CTY Series >

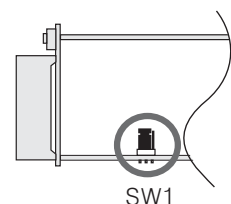

< CTS Series >

4. Please assemble opposite way of the case detachment.
5. Then apply the power to Counter/Timer.

Touch Type Counter/Timer

◎CT Series

It is easy to change input logic by switch.

- Select PNP (Voltage input)
- Select NPN (No-Voltage input)

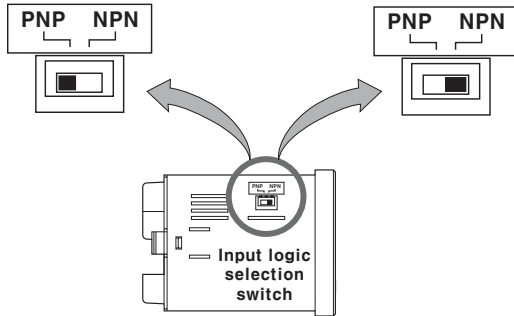

■Output connections

◎Contact output

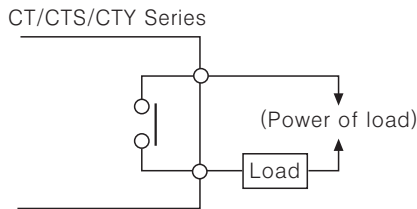

- *Contact capacity is max. 250VAC 3A. Use proper load not to exceed the capacity.
- *When use inductive load (Relay, etc), surge absorber (Diode, Varistor etc) should be connected at both-edge of load.

◎Solid-state output

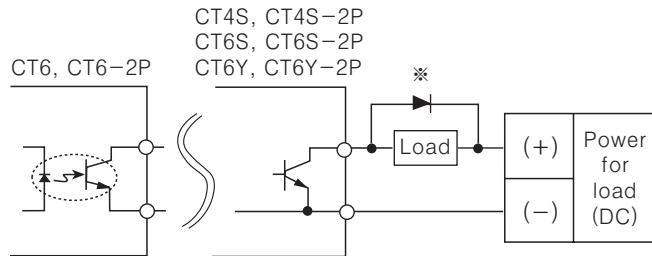

- *Use proper load and power for load not to exceed ON/OFF capacity (Max. 30VDC 100mA) of solid-state output.
- *Be careful not to apply reverse polarity of power.

■Factory default settings

Set item	Model		
	CT6-2P CT6S-2P CT4S-2P CT6Y-2P	CT6 CT6S CT4S CT6Y	CT6-I CT6S-I CT6Y-I
COUNTER	Input mode	Up/Down-C(U/D-C)	
	Max. counting speed	30cps	
	Output mode	F	—
	OUT2(OUT) output time	Hold	—
	OUT1 output time	100ms	—
	Min. reset time	20ms	
	Decimal point	No decimal point	
	Prescale value	6digit : 1.000, 4digit : 1.00	
	Memory protection	CLEr(Power reset)	
TIMER	Time range	6digit : 0.01s ~ 9999.99s 4digit : 0.01s ~ 99.99s	
	Up/Down mode	U(UP)	
	Output mode	OND(ON Delay)	—
	Output time	Hold	—
	Input signal mode	20ms	
Input logic	No-voltage input(NPN)		
Lock key	L.oFF(Lock OFF)		
Counter / Timer	Counter		

■Error display

Error display	Errors	Output status	How to return
Err 1	CPU error	OFF	key, RESET input

(A) Counter

(B) Timer

(C) Temp. controller

(D) Power controller

(E) Panel meter

(F) Tacho/Speed/Pulse meter

(G) Display unit

(H) Sensor controller

(I) Switching power supply

(J) Proximity sensor

(K) Photo electric sensor

(L) Pressure sensor

(M) Rotary encoder

(N) Stepping motor & Driver & Controller

(O) Graphic panel

(P) Production stoppage models & replacement

CTY/CTS/CT Series

Counter mode

Operation mode in Counter

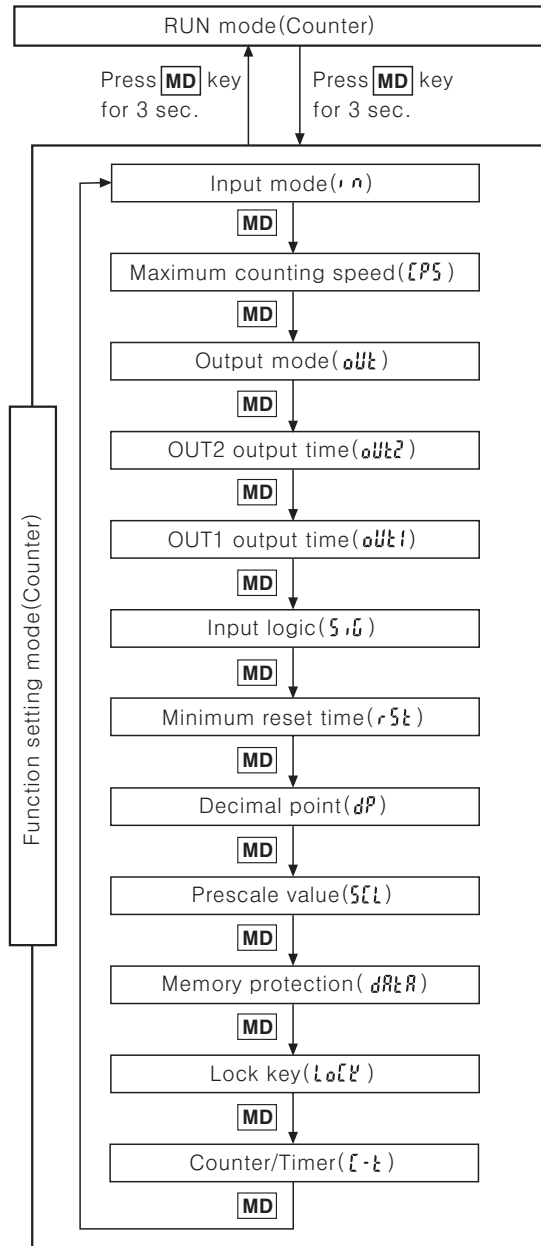

- Press **MD** key for over 3sec., in Counter RUN mode, it advances to Counter function setting mode and press **MD** key for over 3sec in function setting mode, it returns to RUN mode.
(Note) Be careful when it advances to function setting mode during operation, it is reset.
- If no keys are touched for over 60sec., it returns to RUN mode.
- When using this unit as a timer, change as timer (L-t) in Counter/Timer setting item of function setting mode and press **MD** key for over 3sec. then, it advances to RUN mode. (See A-21 for the specific description of Timer.)

Change of setting value(Counter)

Change the setting value in the single preset type

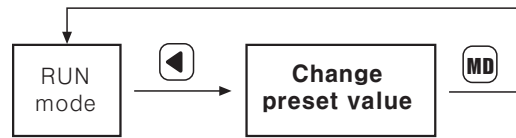

Change the setting value in the dual preset type

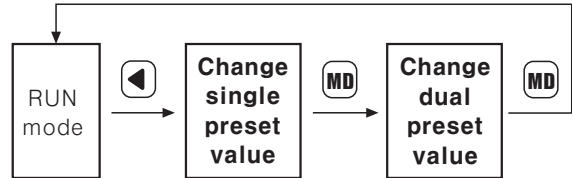

- ※ When register input signal during setting value change, it controls counting and output.
- ※ If no keys are touched for over 60sec., during setting value change, it returns to RUN mode.
- ※ After change setting value as "0", press **RST** or input RESET during RUN mode, output will be maintained as OFF status.
(When set single setting as "0" in output mode "L(T)" it is maintained as ON status.)

Change of batch setting value

Batch counter function is only available in CT6, CT6-2P type.

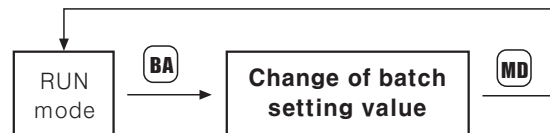

- ※ If you press **BA** key in RUN mode, it will allow you to make change to the batch setting value. After change the batch setting value by same method as the method of Counter setting value changes by **←**, **↓**, **↑** keys, it will return to RUN mode by pressing **MD** key.
When it advances to change the batch preset value, the prior value of the batch counting is displayed.
- ※ Batch setting is limited to single setting mode even in dual setting model.

How to set Lock key

Be sure to set the lock mode in order to protect against accidental or unauthorized key operation.

LoFF (Lock OFF) : Cancellation of the lock mode
"LOCK" OFF

LoL1 (Lock level 1) : Lock **RST** key
"LOCK" ON

LoL2 (Lock level 2) : Lock **←** & **↓** & **↑** key
"LOCK" ON

LoL3 (Lock level 3) : Lock **RST** & **←** & **↓** & **↑** key
"LOCK" ON

Touch Type Counter/Timer

■ Setting function mode(Counter)

(key : Use the or key to change the setting)

Setting mode	How to set(,)
Input mode (i n)	<p>※When "U" or "d" of input mode is set, "S, t, d" of output mode will not be displayed.</p>
Maximum counting speed (CPS)	<p>※Max. counting speed is determined when duty ratio of INA or INB input signal is 1:1 and it is applied to both INA and INB. ※When using setting "d" in output mode, 5kcps and 10kcps are not indicated in the display.</p>
Output mode (oUt)	<p>●Up or Down input mode</p> <p>●Up/Down-A, B, C input mode</p> <p>※As output mode, "F, n" maintains ON status after count up, "OUT2 output time" is not displayed. ※If the maximum counting speed is 5kcps or 10kcps, when change output mode to "d". In order to change counting speed as 30 or 1kcps, configure at function setting mode again.</p>
OUT2 output time (oUt2)	<p>Unit:ms</p> <p>※There is no "OUT1 output time" in single preset model, "OUT2 output time" will be shown as "OUT output time(oUt t)".</p>
OUT1 output time (oUt1)	<p>Unit:ms</p>
Input logic (S, U)	<p>nPn : No-voltage input PnP : Voltage input</p> <p>※The input logic is not changed with and key, because it is under confirmation state of the prior input logic.</p>
Min. reset time (rSt)	<p>Unit:ms</p> <p>※Set the min. external RESET signal width</p>
Decimal point (dP)	<p>● 6 Digit</p> <p>● 4 Digit</p> <p>※Setting the decimal point is applied same to counting value and setting value.</p>
Prescale value (SEL)	<p>※ key : Shift flashing digit</p> <p>※, key : Change the prescale value</p> <p>※Refer to A-18 page for prescale function.</p> <p>※Setting range of prescale value 6Digit : 0.001 ~ 99.999 4Digit : 0.01 ~ 9.99</p>
Memory protection (dAtA)	<p>※CLER : Reset power for count value. (Initialize count value when power off.) rEE : Memorize count value. (Memorize count value the moment when power off.)</p>
Lock key (LoLk)	<p>※Refer to A-13</p>
Counter/Timer (C-t)	<p>※CoUn : Counter t, nE : Timer</p>

(A)
Counter

(B)
Timer

(C)
Temp.
controller

(D)
Power
controller

(E)
Panel
meter

(F)
Tacho/
Speed/
Pulse
meter

(G)
Display
unit

(H)
Sensor
controller

(I)
Switching
power
supply

(J)
Proximity
sensor

(K)
Photo
electric
sensor

(L)
Pressure
sensor

(M)
Rotary
encoder

(N)
Stepping
motor &
Driver &
Controller

(O)
Graphic
panel

(P)
Production
stoppage
models &
replacement

※When selecting the "d" output mode and if 1 kcps is used, the output may not operate normally because of response time of the contact. In this case, be sure to use the solid state output.

※In function setting mode, no external input signal will be accepted and the output will stay in the OFF state.

※There are no output mode and output time setting mode(OUT1, OUT2) of function setting mode in CT6Y-I, CT6S-I, CT6-I models.

CTY/CTS/CT Series

Change of counter setting value

Change the setting value of single preset type(CT6)

- To change the setting value from 175 to 180.

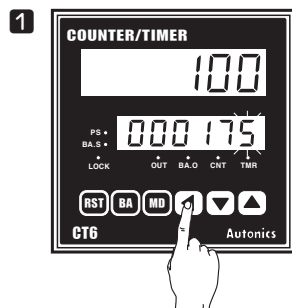

Press key to advance in setting value change mode. Previous setting value is displayed and the first digit 5 flashes. (PS LED ON)

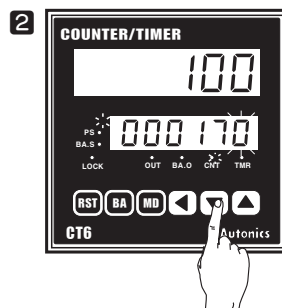

Change "5" to "0" by press key 5 times and shift to the second digit by press key once.

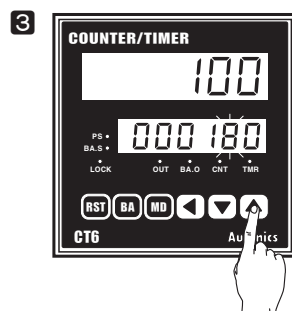

Change "7" to "8" by pressing key once.

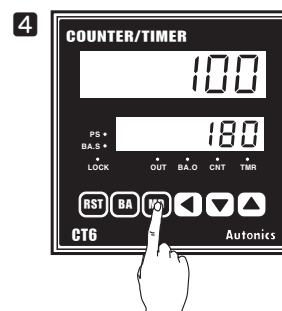

Press key to complete the change of setting value and it returns to RUN mode. (PS LED OFF)

Change the setting value of dual preset type(CT6-2P)

- How to change in the dual preset type : To change the dual setting value from 500 to 1000 when the single setting value is 250 and the dual setting value is 500.

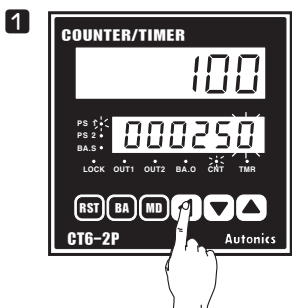

Press key to enter in status of changing setting value. The prior setting value will be displayed and "0" will flash. (PS1 LED ON, PS2 LED OFF)

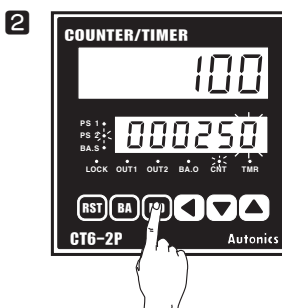

The single setting value is not changed. Move to the change of dual setting value by pressing key. The prior dual setting value "500" is displayed and the "0" will flash.

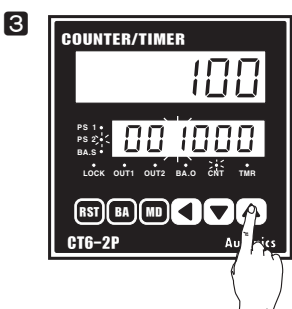

Change "500" to "1000" using , , keys. (It is same with change of single PRESET counter setting value.)

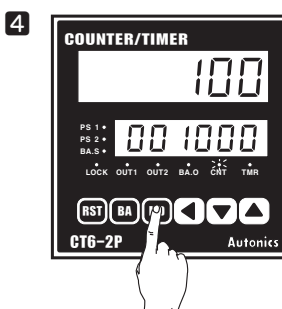

Press key to complete the change of setting value and it returns to RUN mode. (PS1 LED OFF, PS2 LED OFF)

※If no keys are touched for over 60sec., during setting value change, it returns to RUN mode.

※After change setting value as "0", press or input RESET during RUN mode, output will be maintained as OFF status.

(When set single setting as "0" in dual setting type with output mode "E (T)" single output is maintained as ON status.)

※Whenever press key during setting value change, the flashing digit shifts.

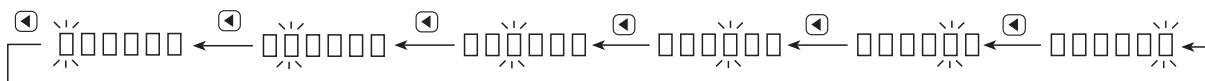

Touch Type Counter/Timer

Batch counter function

Change the setting value of Batch counter

- In case of setting Batch setting value as "50"

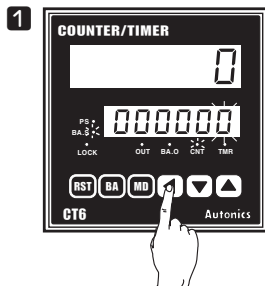

1 Press **BA** key in RUN mode, it advances to Batch setting value mode. (BA.S LED ON)

Then, the first digit "0" flashes and others light on.

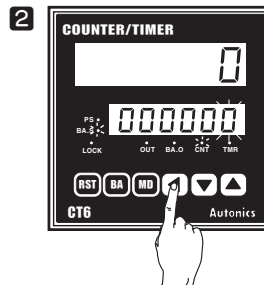

2 Press **▶** key once to advance to the second digit of setting display part.

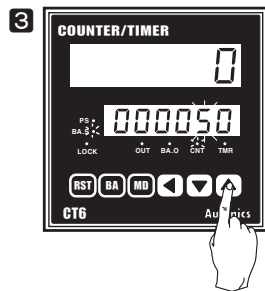

3 Change "5" to "0" by press **▲** key 5 times.

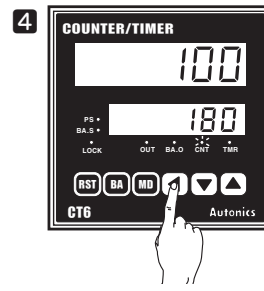

4 Press **MD** key, it completes to set Batch setting value and returns to RUN mode. (BA.S LED OFF)

※ Batch Counter function is only in CT6 and CT6-2P.

※ When advance to Batch setting, if no key is touched for 60sec., it will return to Counter operation mode.

Batch Counter function(CT6)

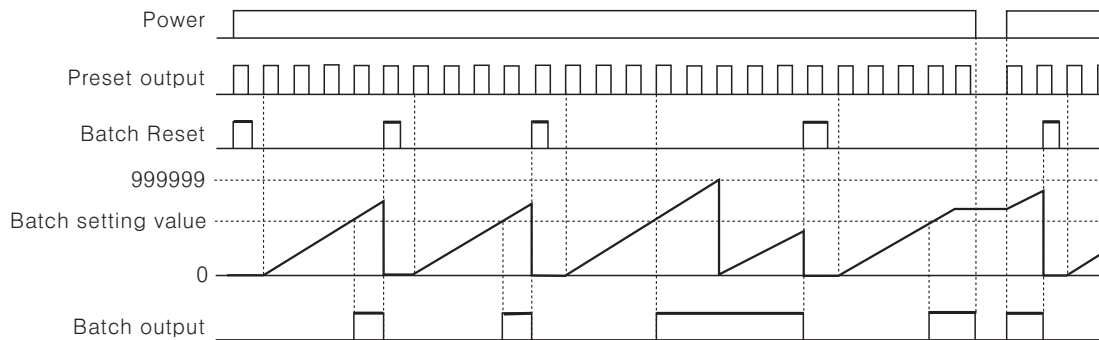

※ When Batch counting value reaches to Batch setting value, Batch counting value is continuously increased and Batch output remains in the ON state until Batch reset is applied.

※ When the Batch output turns on and if the power turns off and then turns on again, the Batch output remains in the ON state until the Batch reset signal is applied.

※ When the Batch counting value counts over 999999, it resets to "0", and it counts up again.

※ If Batch setting value is "0 (ZERO)", Batch counting value counts up, but output remains in the OFF status.

※ The Batch counting value is not changed by front **RST** key or external reset signal.

※ In case of CT6-2P, "Count-up" refers to operation state of output when the counting value is reached to the preset value.

Reset the Batch counting value

When the external terminal of Batch RESET is short-circuited, the Batch counting value is reset.

But the terminal number of Batch Reset is different depending on the input logic.

☞ When Voltage input type (PNP) is selected, please make terminal numbers **10** and **14** short-circuited.

And when No-voltage input type (NPN) is selected, please make terminal number of **11** and **14** short-circuited.

Check the Batch counting value

In order to check the Batch counting value during the Counter operation, press the **BA** key to display both the Batch counting value and preset value.

After checking Batch counting value, it returns to RUN mode by press **MD** key.

※ There is no **BA** key lock function for Batch function.

(A)
Counter

(B)
Timer

(C)
Temp.
controller

(D)
Power
controller

(E)
Panel
meter

(F)
Tacho/
Speed/
Pulse
meter

(G)
Display
unit

(H)
Sensor
controller

(I)
Switching
power
supply

(J)
Proximity
sensor

(K)
Photo
electric
sensor

(L)
Pressure
sensor

(M)
Rotary
encoder

(N)
Stepping
motor &
Driver &
Controller

(O)
Graphic
panel

(P)
Production
stoppage
models &
replacement

CTY/CTS/CT Series

Input operation mode for counter

Ⓐ : Over Min. signal width, Ⓑ : Over 1/2 of Min. signal width

Input mode	Count chart	Notice
U (UP)		※ INA : Count input ※ INB : Inhibition input (Limit the count input of INA) ※ When INA is "L", Configure the inhibition (INB : "L" → "H") or Cancel the inhibition (INB : "H" → "L")
		※ INA : Inhibition input (Limit the count input of INB) ※ INB : Count input ※ When INB is "H", Configure the inhibition (INB : "H" → "L") or Cancel the inhibition (INB : "L" → "H")
d (DOWN)		※ INA : Count input ※ INB : Inhibition input (Limit the count input of INA) ※ When INA is L, Configure the inhibition (INB : "L" → "H") or Cancel the inhibition (INB : "H" → "L")
		※ INB : Count input ※ INA : Inhibition input (Limit the count input of INB) ※ n = Setting value (Preset value) ※ When INB is H, Configure the inhibition (INB : "H" → "L") or Cancel the inhibition (INB : "L" → "H")
Ud-A (Up/Down-A) Command input		※ INA : Count input ※ INB : Command input of Count up/down ※ When INB is L, count increases. When INB is H, count decreases.
Ud-b (Up/Down-B) Individual input		※ INA : Count down input ※ INB : Count up input ※ When INA and INB are applied L to H at same time, the count remains unchanged.
Ud-C (Up/Down-C) Phase difference input		※ When using A, B phase of encoder and connecting to INA, INB, please set counter input mode (ⓐ) as phase difference input (Ud-C).

※ Ⓐ : Over Min. signal width, Ⓑ : Over 1/2 of Min. signal width.

If the signal width of Ⓐ or Ⓑ is less than min. signal width, ±1 of count error is occurred.

※ "H" and "L"

	Voltage input (PNP)	No-voltage input (NPN)
H	5-30VDC	Short circuit
L	0-2VDC	Open

※ Min. signal width by counting speed

Counting speed	Min. signal width
1cps	500ms
30cps	16.7ms
1kcps	0.5ms
5kcps	0.1ms
10kcps	0.05ms

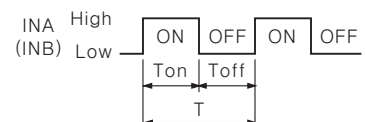

※ Ton, Toff : Min. signal width

Touch Type Counter/Timer

Application of Prescale function

This function is to indicate specific unit or optional multiple multiplying configured scale value by count value.

Ex1) Volume control by Counter and Limit Switch

In order to count 10 sheets of paper is produced when the cutter operates 1 time as below application, inner counter counts whenever the limit switch is operated as 1, 2, 3 times... if preset value is configured as 10 in function setting mode and indicates 10, 20, 30... multiplying scale value depending on count value.

Ex2) Length control by Counter(CT6) and Encoder

In case of cutting paper as 300mm using a 50mm diameter (D) roller connected with Encoder of 1000 pulse.

- Rectify the run-length of roller per 1 pulse, it is 0.157mm. (Refer to formula of prescale value.)
 - Configure the value as a prescale value (51) and 300mm of the cutting length as preset value of counter.
 - Counter counts as 0.157mm per 1 pulse, indicates 300mm and outputs when 1,911 pulse is inputted.
- The decimal point setting (dP) function is not used.
- But when selecting "----x----" in decimal point setting (dP) mode and set preset value of counter as 300.000 same with decimal point, 300.027mm is indicated and outputted for inputting 1,911 of pulse.
- It is available to control accurately depending on decimal point.

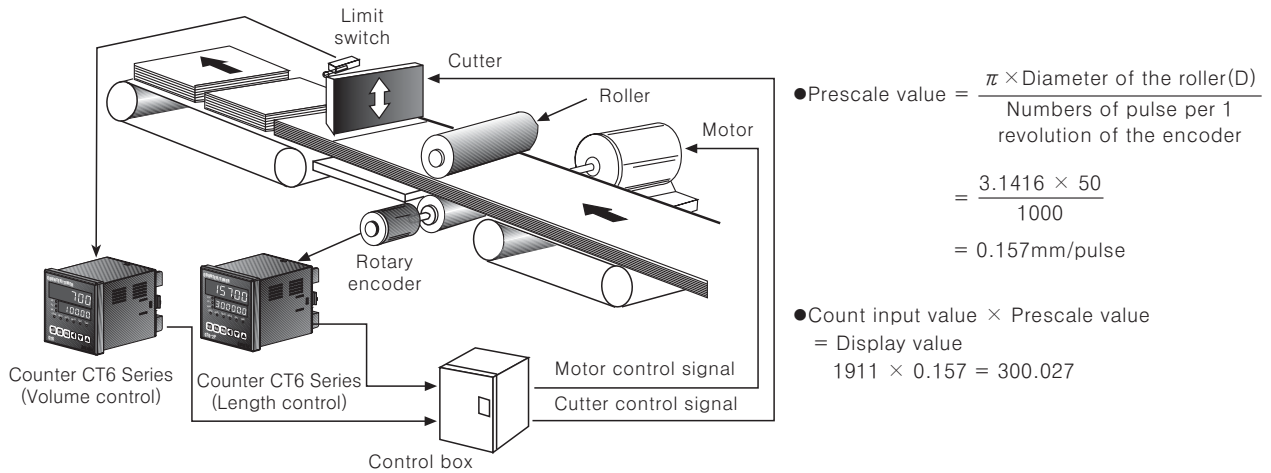

Application of Batch Counter function

○In case, put 5 products in a box then pack the boxes when they reaches to 200

- Counter preset value : Preset value (setting value) = "5", Batch setting value = "200"
- When the count value of Counter reaches to the preset value "5", the count value of Batch Counter will be increased by "1" and the control output (OUT) will be on. When the control box receives the control output (OUT), it moves the full box so the next empty box can be filled.
- When the count value of Batch reaches to "200", Batch output will be ON.
- Then the control box stops conveyor and provides a control signal for packing.

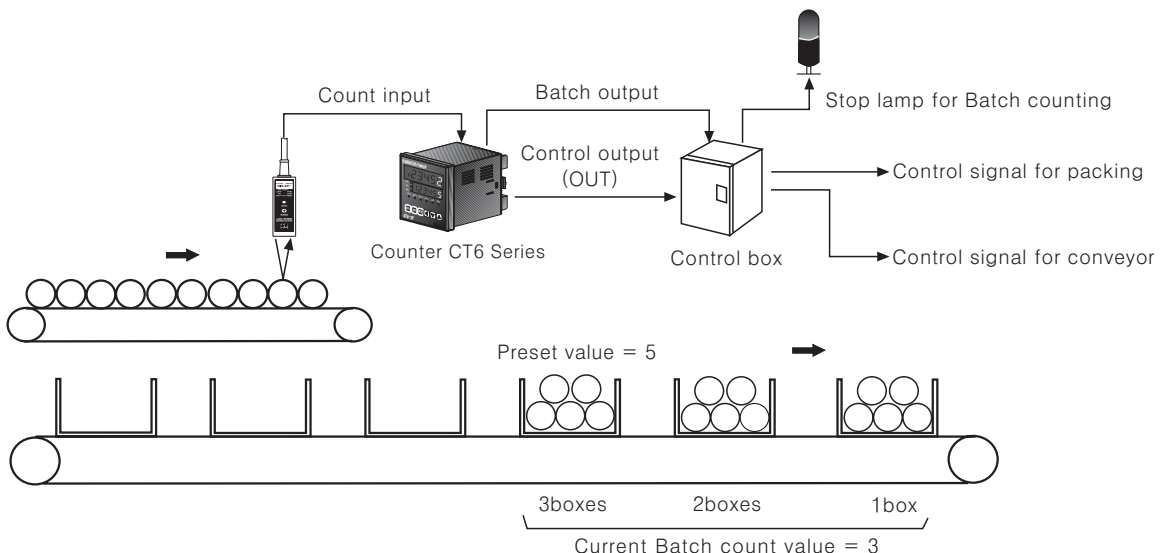

(A) Counter

(B) Timer

(C) Temp. controller

(D) Power controller

(E) Panel meter

(F) Tacho/Speed/Pulse meter

(G) Display unit

(H) Sensor controller

(I) Switching power supply

(J) Proximity sensor

(K) Photo electric sensor

(L) Pressure sensor

(M) Rotary encoder

(N) Stepping motor & Driver & Controller

(O) Graphic panel

(P) Production stoppage models & replacement

CTY/CTS/CT Series

Output operation mode(Counter)

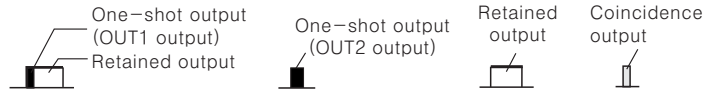

Output mode	Input mode			Operation
	Up	Down	Up/Down A, B, C	
F (F)				<ul style="list-style-type: none"> After count up, display value increases or decreases until Reset signal is applied and retained output is maintained.
N (N)				<ul style="list-style-type: none"> After count up, display value and retained output are maintained until Reset signal is applied.
C (C)				<ul style="list-style-type: none"> Display value will be Reset Start status as soon as count up. OUT1 retained output will be OFF after OUT2 one-shot time. The one-shot output time of OUT1 is operated regardless of OUT2 output.
R (R)				<ul style="list-style-type: none"> Display value after count up will be Reset Start status after OUT2 one-shot time. OUT1 retained output will be OFF after OUT2 one-shot time. The one-shot output time of OUT1 is operated regardless of OUT2 output.
K (K)				<ul style="list-style-type: none"> After count up, display value increases or decreases until Reset signal is applied. OUT1 retained output will be OFF after OUT2 one-shot time. The one-shot output time of OUT1 is operated regardless of OUT2 output.
P (P)				<ul style="list-style-type: none"> After count up, display value is maintained during OUT2 one-shot time and counting operation will be Reset Start status as soon as OUT2 output is ON. OUT1 retained output will be OFF after OUT2 one-shot time. The one-shot output time of OUT1 is operated regardless of OUT2 output.
Q (Q)				<ul style="list-style-type: none"> After count up, display value increases or decreases during OUT2 one-shot time. OUT1 retained output will be OFF after OUT2 one-shot time. The one-shot output time of OUT1 is operated regardless of OUT2 output.
A (A)				<ul style="list-style-type: none"> After count up, display value and OUT1 retained output are maintained until Reset signal is applied. The one-shot output time of OUT1 is operated regardless of OUT2 output.

*The output of single preset type is operating the same as OUT2 of dual preset type.

Touch Type Counter/Timer

Output mode	Up/Down – A, B, C	Operation
5 (S)		<p style="text-align: right;">Retained output Coincidence output </p> <p>※OUT1 and OUT2 keeps ON state in following condition ; Display value \geq Preset 1 Display value \geq Preset 2</p>
5 (T)		<p>※OUT1 keeps OFF state when display value is smaller than Preset 1 value, but if Preset 2 is "0", OUT1 keeps ON state. (But, if preset is "0", OUT1 keeps ON state.)</p> <p>※OUT2 keeps ON state when display value is equal or larger than Preset 2.</p>
d (D)		<p>※When display value is equal to setting value(PRESET1, PRESET2) only, OUT1 or OUT2 output keeps ON state.</p> <p>※When setting 1kcps for counting speed, solid state contact output should be used. (When contact output is used, it can't be operated normally because of response time of contact.)</p>

※The single preset type output(OUT) is operated as OUT2 of dual preset type.

Counter operation of Indication model(CT6Y-I, CT6S-I, CT6-I)

●In case of input mode is Up(\uparrow)

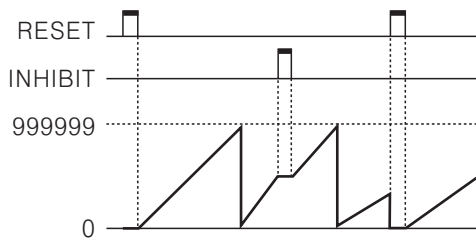

●In case of input mode is Down(\downarrow)

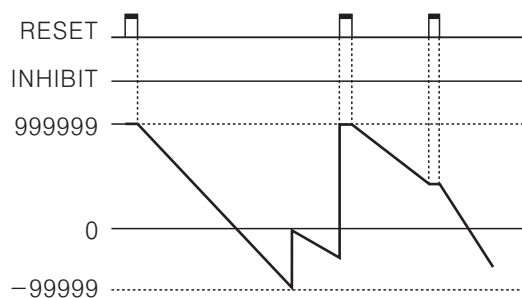

●In case of the input mode is Command input($\uparrow\downarrow$ -A), Individual input($\uparrow\downarrow$ -b), Phase difference input($\uparrow\downarrow$ -c)

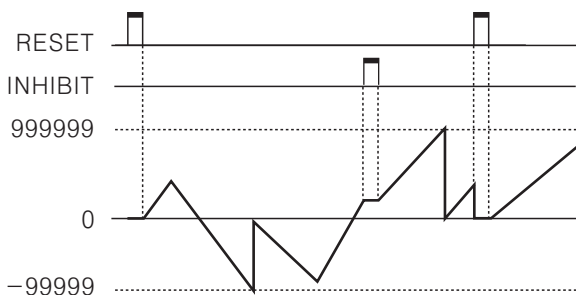

※If "dRA" setting value of function setting mode(count) is "ELER", count value is reset or count value is memorized when it is "rEE".

※CT6-I has an INHIBIT terminal only.

(A) Counter

(B) Timer

(C) Temp. controller

(D) Power controller

(E) Panel meter

(F) Tacho/Speed/Pulse meter

(G) Display unit

(H) Sensor controller

(I) Switching power supply

(J) Proximity sensor

(K) Photo electric sensor

(L) Pressure sensor

(M) Rotary encoder

(N) Stepping motor & Driver & Controller

(O) Graphic panel

(P) Production stoppage models & replacement

CTY/CTS/CT Series

■ Timer mode

○ Operation mode in Timer

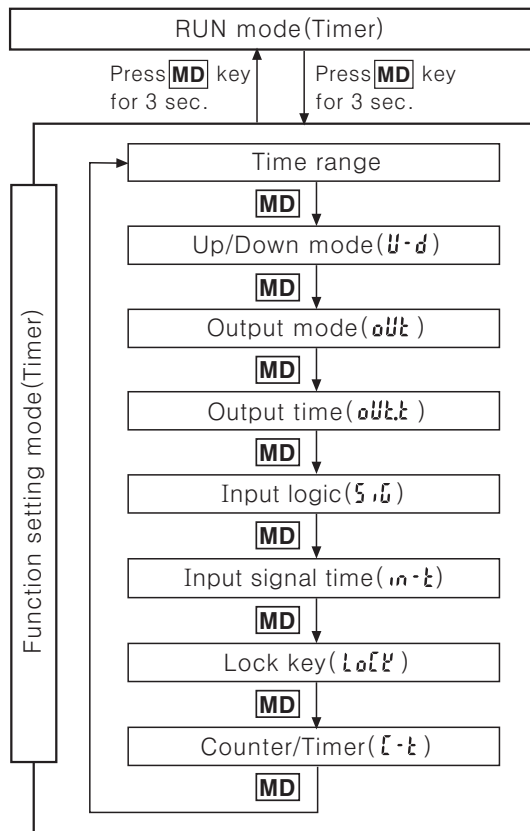

- Press **MD** key for over 3sec., in Timer RUN mode, it advances to Timer function setting mode and press **MD** key for over 3sec in function setting mode, it returns to RUN mode.
(Note) Be careful when it advances to function setting mode during operation, it is reset.
- If no keys are touched for over 60sec., it returns to RUN mode.
- After select counter(C.t) in Counter/Timer setting item of function setting mode and press MD key for over 3sec. then, it advances to Counter RUN mode.

■ Change of setting value in Timer operation

○ To change setting value in case of the output is not FLK



○ To change setting value in case of the output is not FLK

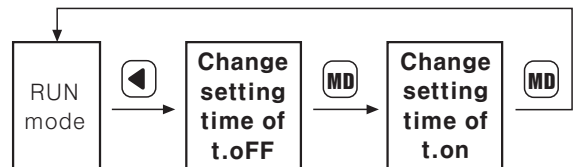

- When dual preset type is used for timer, the setting time is limited as one and only OUT2 is operated.
- If no keys are touched for over 60sec., after advance to setting value change mode, it returns to RUN mode. Be careful not to press **MD** key, output is not operated and same result can occur when press **MD** key after OFF power and ON again in change mode after advance to change mode, in case, output mode is OND.2, FLK.2.

○ Change the batch setting value

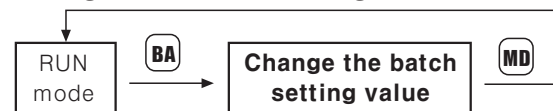

- Press **BA** key in RUN mode, it advances to Batch setting value change mode. Press **MD** key after change Batch setting value same as counter setting value change by **←**, **↓**, **↑** keys, it completes to change Batch setting value and advances to RUN mode. When it advances to Batch setting value change mode, it displays previous Batch count value.
- Press **MD** key to return to RUN mode after advance in Batch setting value change mode.
* Batch setting is limited to single setting mode even in dual setting model.

■ Time range

1) 6 Digit type Time range

Time range	Function setting mode	
	Timing display	Preset display
0.01s to 9999.99s	SEC	999999
0.1s to 99999.9s	SEC	999999
1s to 999999s	SEC	999999
0.01s to 99m 59.99s	h S	995999
0.1s to 999m 59.9s	h S	999599
0.1m to 99999.9m	h	999999
1m to 999999m	h	999999
1s to 99h 59m 59s	H h S	995959
1m to 9999h 59m	H h	999959

* Model : CT6Y-2P, CT6Y, CT6Y-I, CT6S-2P, CT6S, CT6S-I, CT6-2P, CT6, CT6-I

2) 4 Digit type Time range

Time range	Function setting mode	
	Timing display	Preset display
0.01s to 99.99s	SEC	9999
0.1s to 999.9s	SEC	9999
1s to 9999s	SEC	9999
1s to 99m 59s	h S	9959
0.1m to 999.9m	h	9999
1m to 9999m	h	9999
1m to 99h 59m	H h	9959
1h to 9999h	H	9999

* Model : CT4S-2P, CT4S

Touch Type Counter/Timer

Setting function mode(Timer)

(**MD** key : Use the **▲** or **▼** key to Change the setting)

Setting mode	How to set
Time range (SEC / \bar{n} n / Hour)	<p>※The time range for 6digit type</p> <p>※The time range for 4digit type</p>
UP/DOWN mode (U-d)	<p>U \leftrightarrow d</p> <p>※UP : Time proceeds from 0(ZERO) to the setting value. DOWN : Time proceeds from the setting value to 0(ZERO).</p>
Output mode (out)	<p>ond \rightarrow ond.1 \rightarrow ond.2 \rightarrow FLY \rightarrow FLY.1 \rightarrow FLY.2 \rightarrow int \rightarrow int.1 \rightarrow ofd</p>
Output time (out.t)	<p>10 \rightarrow 50 \rightarrow 100 \rightarrow 200 \rightarrow 500 \uparrow Hold \leftarrow 5000 \leftarrow 2000 \leftarrow 1000</p> <p>Unit: ms</p> <p>※It is operation time of control output according to output mode.</p>
Input logic (S.n)	<p>nPn : No-voltage input PnP : Voltage input</p> <p>※The input logic is not changed with ▲ and ▼ key, because it is under confirmation state of the prior input logic.</p>
Input signal time (int.t)	<p>1 \leftrightarrow 20 Unit: ms</p> <p>※CTS series : Min. external INA, INH, RESET signal width CT series : Min. external INA, INHIBIT, RESET, BATCH, RESET signal width</p>
Lock key(Lock) (LoL)	<p>LoFF \rightarrow LoL.1 \rightarrow LoL.2 \rightarrow LoL.3</p>
Counter/Timer (C-t)	<p>CoUn \leftrightarrow t, nE</p> <p>※ CoUn : Counter t, nE : Timer</p>

- ※In function setting mode, no external input signal will be accepted and the output will stay in the OFF status.
- ※In case of output mode is FKL, INT, INT1, OFD, there is no output time setting in the function setting mode.
- ※In the indicator type(CT6Y-I, CT6S-I, CT6-I), there are no output modes or output times in the function setting mode.
- ※Control output operates as OUT2 in the dual preset type(CT6Y-2P, CT6S-2P, CT4S-2P, CT6-2P), and OUT1 always remains in "OFF" status. (Time setting is limited to one time.)
- ※If no key is touched for 60 sec., in change status of setting time(PRESET value) the timer will return to RUN mode.

How to set Lock key

Be sure to set the lock mode in order to protect against accidental or unauthorized key operation.

- LoFF** (Lock OFF) : Cancellation of the lock mode
"LOCK" OFF
- LoL.1** (Lock level 1) : Lock **(RST)** key
"LOCK" ON
- LoL.2** (Lock level 2) : Lock **(▲) & (▼) & (▲)** key
"LOCK" ON
- LoL.3** (Lock level 3) : Lock **(RST) & (▲) & (▼) & (▲)** key
"LOCK" ON

- (A) Counter
- (B) Timer
- (C) Temp. controller
- (D) Power controller
- (E) Panel meter
- (F) Tacho/Speed/Pulse meter
- (G) Display unit
- (H) Sensor controller
- (I) Switching power supply
- (J) Proximity sensor
- (K) Photo electric sensor
- (L) Pressure sensor
- (M) Rotary encoder
- (N) Stepping motor & Driver & Controller
- (O) Graphic panel
- (P) Production stoppage models & replacement

CTY/CTS/CT Series

Change of the setting time of Timer

Change of setting time in case, the output is FLK(CT6S)

Change t.oFF time from 30sec. to 50sec., t.on setting from 40sec. to 20sec.
(Output mode : FLK, Time range : 99999.9)

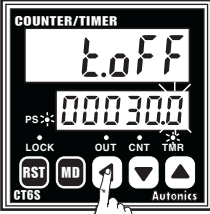
1  Advance to setting time change mode by press **MD** key. Shift the flashing digit to position "3" by press **←** key twice. (PS LED ON)

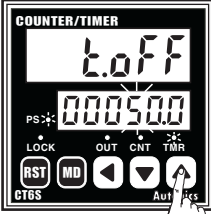
2  Change "3" to "5" by press **▲** key twice.

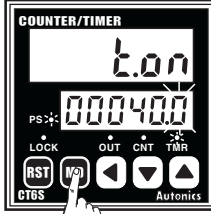
3  Press **MD** key to complete t.oFF time set and advance to t.on setting time change mode.

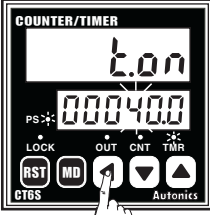
4  Shift to the third position "4" by press **←** key twice.

5  Change "5" to "0" by press **▼** key 5 times.

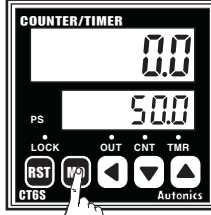
6  Press **MD** key to complete setting time change and return to RUN mode. (PS LED OFF)

Change of setting time in case of the output is not FLK(CT6S)

Change the setting time from 15.0 to 20.0 (Output mode : OND, Time range : 99999.9)

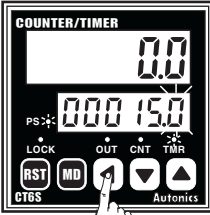
1  Advance to setting time change mode by press **MD** key. Shift the second digit to position "5" by press **←** key once. (PS LED ON)

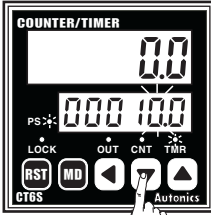
2  Change "5" to "0" by press **▼** key 5 times.

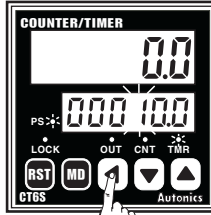
3  Shift to the third position "1" by press **←** key once.

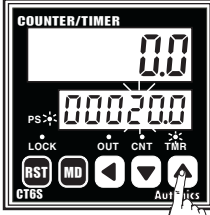
4  Change "1" to "2" by press **▲** key once.

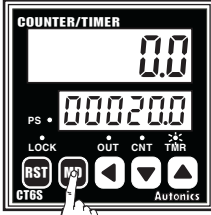
5  Press **MD** key to complete setting time change and return to timer RUN mode. (PS LED OFF)

- ※ When advance to setting time change mode, time will progress continuously.
- ※ If no keys are touched for over 60sec., after advance to setting value change mode, it returns to RUN mode. Be careful not to press **MD** key, output is not operated and same result can occur when press MD key after OFF power and ON again in change mode after advance to change mode, in case, output mode is OND.2, FLK.2.
- ※ Whenever press **←** key during setting value change, the flashing digit shifts.

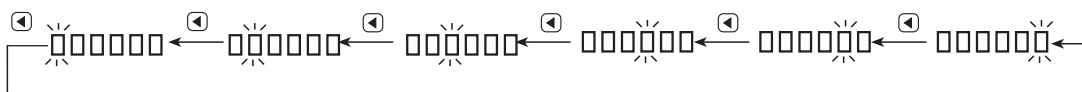

※ When use CT6Y-2P, CT4S-2P, CT6S-2P, CT6-2P as a timer, there is no dual preset function.

Touch Type Counter/Timer

Batch Counter function(Timer)

When it reaches the batch setting value to count the number of Time-up, the batch output will be ON. But when the output mode is "FLK", the number of Time-ups will be 2 times because it will count both Toff, and Ton time-ups.

- ☞ When time reaches the Toff setting time, Batch count value will be increased. And when it reaches the Ton time, Batch count value will be increased.

How to set the batch setting value

Batch setting value is not for setting the time, it sets the count value like a counter. Refer to A-23 for the batch setting value using as a timer, it is same as a counter.

Batch Counter function

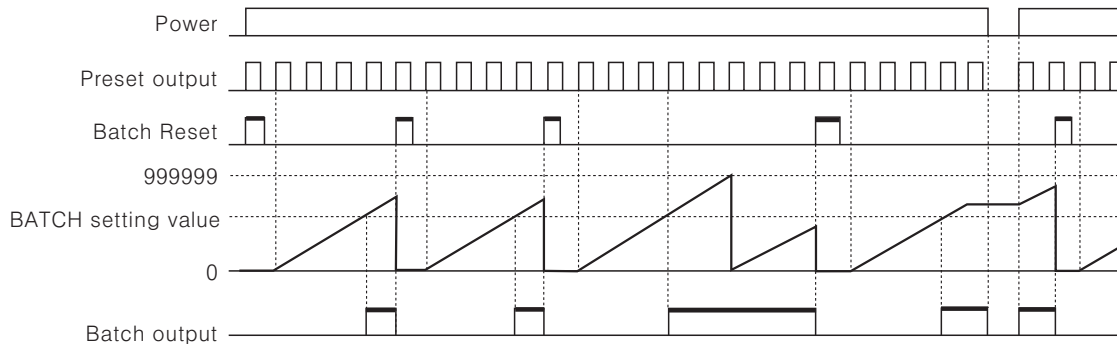

- ※ When count value of the number of Time-up of setting value reaches the batch setting value, the batch output is operated and the batch count value is increased until the batch reset signal is applied and the batch output returns to the OFF status.
- ※ When the batch output turns on and if the power turns off and then turns on again, the batch output remains in the ON state until the batch reset signal is applied.
- ※ If batch setting value is "0(ZERO)", the batch count value is increased, but the batch output remains OFF status.
- ※ If batch setting value is 0(ZERO), the batch count value counts up, but the batch output remains OFF state.
- ※ The batch count value is not changed by front **RST** key or external reset signal.

Reset the Batch count value

When the terminal of Batch RESET is externally short-circuited, the BATCH count value will be reset. But the Batch RESET is different dependent on the input logic setting.

- ☞ When Voltage input type (PNP) is selected, please make terminal numbers **10** and **14** short-circuited. And when No-voltage input type (NPN) is selected, please make terminal number of **11** and **14** short-circuited.

Check the Batch count value

In order to check the Batch count value during the Timer operation, press the **BA** key to display both the Batch count value and setting value. After check Batch count value, it returns to RUN mode by press **MD** key.

- ※ There is no **BA** key lock function for Batch function.

Application of Batch counter

Fill milk into the bottle for 30sec. (Setting time), then when 500 bottles are completed, turn Batch counting finish lamp on. (Setting time : 30sec., Batch setting value : 500)

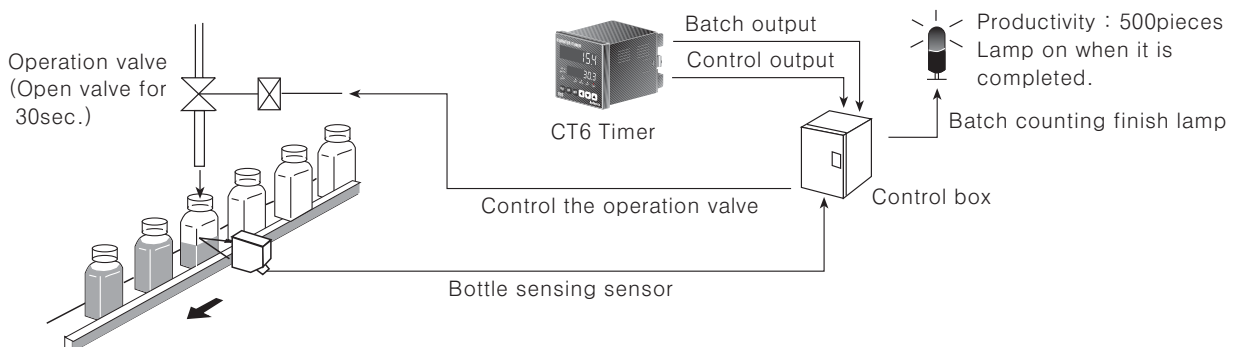

(A) Counter

(B) Timer

(C) Temp. controller

(D) Power controller

(E) Panel meter

(F) Tacho/Speed/Pulse meter

(G) Display unit

(H) Sensor controller

(I) Switching power supply

(J) Proximity sensor

(K) Photo electric sensor

(L) Pressure sensor

(M) Rotary encoder

(N) Stepping motor & Driver & Controller

(O) Graphic panel

(P) Production stoppage models & replacement

CTY/CTS/CT Series

Output operation mode(Timer)

One-shot output (t=One-shot output time)  Retained output

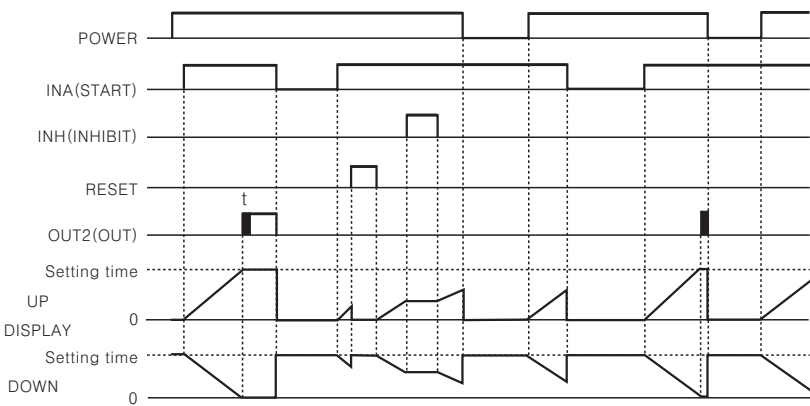
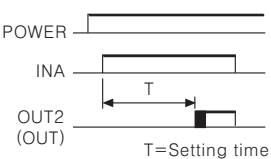
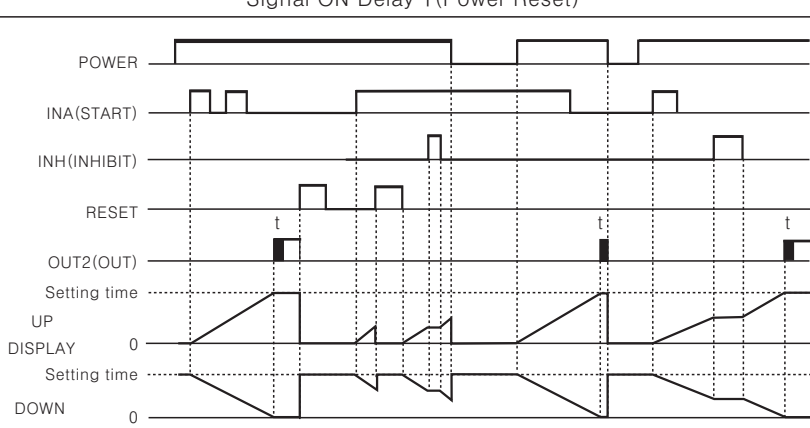
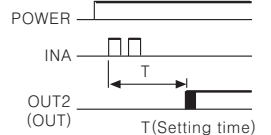
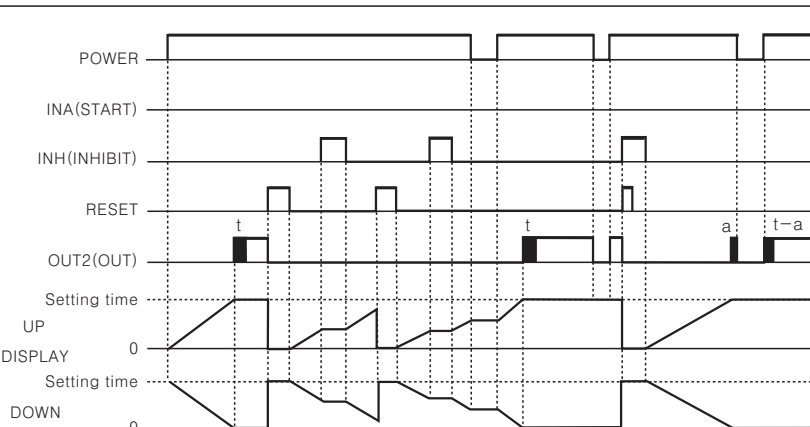
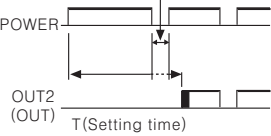
Output mode	Time chart	Operation
ond (OND)	<p>Signal ON Delay(Power Reset)</p> 	<ol style="list-style-type: none"> 1)Time starts when INA signal turns on. When INA signal turns off, time resets. 2)Time starts when power turns on and when reset turns off during INA signal on. 3)Control output operates as retained or one-shot. 
ond.1 (OND.1)	<p>Signal ON Delay 1(Power Reset)</p> 	<ol style="list-style-type: none"> 1)Time starts when INA signal turns on, if INA signal is applied repeatedly, only initial signal is recognized. 2)Time starts when power turns on and when reset turns off during INA signal on. 3)Control output operates as retained or one-shot. 4)The initial signal is effective when input INA repeatedly. 
ond.2 (OND.2)	<p>Power ON Delay(Power Hold)</p>  <p>*Memory protection of the indication value:10 years</p>	<ol style="list-style-type: none"> 1)Time starts when power turns on. (There is no INA function) 2)Time resets when reset turns on. Time starts when reset turns off. 3)Control output operates as retained or one-shot. 4)It memorizes display value at the moment of power off. 

※Power RESET : There is no memory protection. (Initialize the indication value when power is off.)

※Power Hold : There is memory protection. (Memorize the indication value for a moment of power-off, indicate the memorized indication value when power is applied.)

Touch Type Counter/Timer

Output operation mode(Timer)



Output mode	Time chart	Operation
FLU (FLK)	Flicker(Power Reset)	<ol style="list-style-type: none"> Time starts when INA signal turns on. If INA signal is applied repeatedly, only initial signal is recognized. Time starts when power turns on and when reset turns off during INA signal on. Control output operates as retained output, output turns off for the Toff time and turns on for the Ton time repeatedly. $Ta+Tb=Toff$ setting time. The Ton time and the Toff time must be set individually. FLK output mode has retained output. In case of using the contact output, min. setting time must be set over 100ms.
FLU.1 (FLK.1)	Flicker 1(Power Reset)	<ol style="list-style-type: none"> Time starts when INA signal turns on. If INA signal is applied repeatedly, repeatedly only initial signal is recognized. Time starts when power turns on and when reset turns off during INA signal on. Control output operates as retained output. In case of using the contact output, min. setting time must be set over 100ms.
	Retained output 	
	One-shot output 	<ol style="list-style-type: none"> Time starts when INA signal turns on, if INA signal is applied repeatedly, only initial signal is applied. Time starts when power turns on and when reset turns off during INA signal on. Control output operates as one-shot. In case of using the contact output, min. setting time must be set over 100ms.

※Power Reset : There is no memory protection. (Initialize the indication value when power is off.)

※Power Hold : There is memory protection. (Memorize the indication value for a moment of power-off, indicate the memorized indication value when power is applied.)

(A) Counter

(B) Timer

(C) Temp. controller

(D) Power controller

(E) Panel meter

(F) Tacho/Speed/Pulse meter

(G) Display unit

(H) Sensor controller

(I) Switching power supply

(J) Proximity sensor

(K) Photo electric sensor

(L) Pressure sensor

(M) Rotary encoder

(N) Stepping motor & Driver & Controller

(O) Graphic panel

(P) Production stoppage models & replacement

CTY/CTS/CT Series

Output operation mode(Timer)

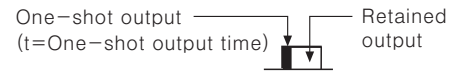

Output mode	Time chart	Operation
FLK.2 (FLK.2)	<p style="text-align: center;">FLICKER 2(POWER HOLD)</p> <p>Retained output</p> <p>Setting time</p> <p>Up 0</p> <p>Setting time</p> <p>Display Down 0</p> <p>※Memory protection of the indication value:10 years</p>	<ol style="list-style-type: none"> 1)Time starts when INA signal turns ON. If INA signal is applied repeatedly, only initial signal is recognized. 2)Control output operates as retained. 3)Control output will be reversed when it reaches to setting time. (At the initial start, OUT2 control output is OFF.) 4)In case of using the contact output, min. setting time must be set over 100ms. <p style="text-align: center;">T:Setting time</p>
	<p>One-shot output</p> <p>Setting time</p> <p>Up 0</p> <p>Setting time</p> <p>Display Down 0</p> <p>※Memory protection of the indication value:10 years</p>	<ol style="list-style-type: none"> 1)Time starts when INA signal turns ON. If INA signal is applied repeatedly, only initial signal is recognized. 2)Control output operates as one-shot output when reaches to the setting time. 3)Time starts when power turns ON and when reset turns OFF during INA signal on. 4)In case of using the contact output, min. setting time must be set over 100ms. <p style="text-align: center;">T:Setting time</p>
INT (INT)	<p style="text-align: center;">INTERVAL(POWER RESET / SIGNAL RESET)</p> <p>Setting time</p> <p>Up 0</p> <p>Setting time</p> <p>Display Down 0</p>	<ol style="list-style-type: none"> 1)During INA is ON, Time starts and control output turns ON. When it reaches to setting time, the indication value and control output will be reset automatically. 2)When INA is OFF, time resets. 3)During INA signal on Power OFF:Processing time and control output Reset Power ON:Time Reset Reset ON:Processing time and control output Reset Reset OFF:Time Reset <p style="text-align: center;">T:Setting time</p>

※POWER RESET : There is no memory protection. (Initialize the indication value when power is off.)

※POWER HOLD : There is memory protection. (Memorize the indication value for a moment of power-off, indicate the memorized indication value when power is applied.)

Touch Type Counter/Timer

Output operation mode(Timer)

One-shot output (t=One-shot output time)  Retained output

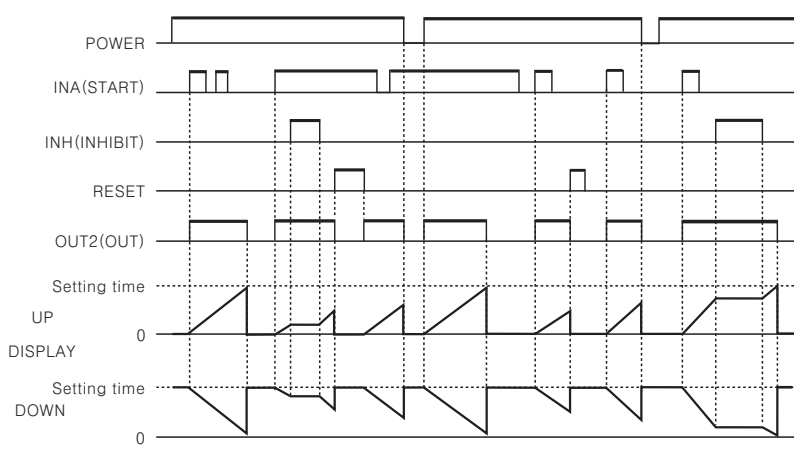
Output mode	Time chart	Operation
int.1 (INT.1)	Interval 1 (Power Reset)	<ol style="list-style-type: none"> Control output turns ON and time starts when INA signal turns ON. If INA signal is applied repeatedly, only initial signal is recognized. When it reaches to setting time, indication value and control output are reset automatically. Time starts when power turns ON and when reset turns OFF during INA signal on. Control output is ON when time is progressing. 
	Signal OFF Delay (Power Reset)	

※Power Reset : There is no memory protection. (Initialize the indication value when power is off.)

Timer operation of Indication model(CT6-I, CT6S-I)

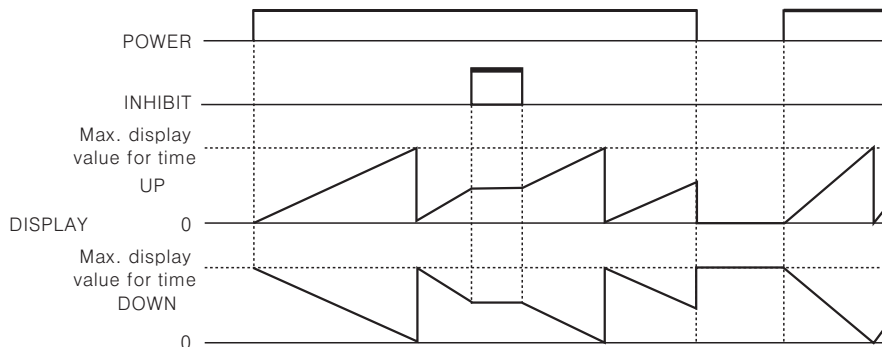

※When power is off, processing time is initialized. (There is no memory protection.)

(A) Counter

(B) Timer

(C) Temp. controller

(D) Power controller

(E) Panel meter

(F) Tacho/Speed/Pulse meter

(G) Display unit

(H) Sensor controller

(I) Switching power supply

(J) Proximity sensor

(K) Photo electric sensor

(L) Pressure sensor

(M) Rotary encoder

(N) Stepping motor & Driver & Controller

(O) Graphic panel

(P) Production stoppage models & replacement

CTY/CTS/CT Series

■ Proper usage

◎ Turning power ON/OFF

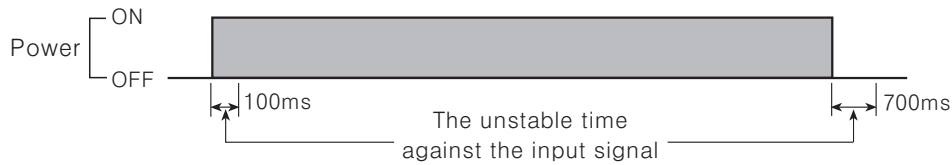

- During 100ms after applying power, 700ms after cutting power, it is the unstable time for rising and fall of power
- Please apply the input signal after 100ms from power supplied and apply the power after 700ms from power cut.

◎ Input signal line

- Use as short a cable from the sensor to this unit as possible.
- Use shielded cable for long input line.
- Keep input cables separate from power cables.

◎ Input logic selection

When selecting or changing the input logic, the power source must be cut off. Then select the input logic according to the method of changing input logic.

◎ Contact counting input

If applying contact input at high speed mode (1k, 5k, 10k), it may miscount by chattering. Therefore, set low speed mode. (1 or 30cps)

◎ Test circuit dielectric, impulse voltage and measure insulated resistor by installing in control panel,

- Separate the unit from control box circuit.
- Short-circuit all terminals in terminal block.

◎ Do not use this unit in the following places

- A Place where ambient temperature is over 55°C or less than -10°C.
- A Place where ambient humidity is over 85%RH or where condensation occurs by temperature changes.
- A Place where there is severe vibration or impact.
- A Place where strong magnetic field or electric noise is generated.
- A Place where strong alkalis or acids are used.
- A Place where there are direct rays of the sun.

◎ Use under these conditions

- Indoors
- Maximum height 2000m
- Pollution Degree 2
- Installation category II