

**PULSE METER
MP5M SERIES**

M A N U A L



Thank you very much for selecting Autonics products.
For your safety, please read the following before using.

Caution for your safety

- ※ Please keep these instructions and review them before using this unit.
- ※ Please observe the cautions that follow:
Warning Serious injury may result if instructions are not followed.
Caution Product may be damaged, or injury may result if instructions are not followed.
- ※ The following is an explanation of the symbols used in the operation manual.
 : Injury or danger may occur under special conditions.

Warning

- In case of using this unit with machineries (Nuclear power control, medical equipment, vehicle, train, airplane, combustion apparatus, entertainment or safety device etc), it requires installing fail-safe device, or contact us for information on type required.**
It may result in serious damage, fire or human injury.
- It must be mounted on panel.**
It may give an electric shock.
- Do not repair or check up when power on.**
It may give an electric shock.
- Do not disassemble and modify this unit, when it requires. If needs, please contact us.**
It may give an electric shock and cause a fire.
- Please check the number of terminal when connect power line or measuring input.**
It may cause a fire.

Caution

- This unit shall not be used outdoors.**
It might shorten the life cycle of the product or give an electric shock.
- When wire connection for power input and measuring input, the tightening strength for screw bolt on terminal block should be over than 0.74N · m ~ 0.90N · m.**
It may result in malfunction or fire due to contact failure.
- Please observe specification rating.**
It might shorten the life cycle of the product and cause a fire.
- Do not use the load beyond rated switching capacity of Relay contact.**
It may cause insulation failure, contact melt, contact failure, relay broken, fire etc.
- In cleaning the unit, do not use water or an oil-based detergent.**
It might cause an electric shock or fire that will result in damage to this product.
- Do not use this unit at place where there are flammable or explosive gas, humidity, direct ray the sun, radiant heat, vibration, impact etc.**
It may cause a fire or explosion.
- Do not inflow dust or wire dregs into inside of this unit.**
It may cause a fire or mechanical trouble.
- Please connect properly after checking the polarity of measuring terminals.**
It may cause a fire or explosion.

※ The above specification are changeable without notice anytime.

Ordering information

	MP	5	M	-	4	N
	①	②	③	④	⑤	
① Series	MP	Pulse meter				
② Digit	5	5Digit(99999)				
③ Size	M	DIN Size W72 × H72mm				
④ Power supply	4	100-240VAC 50/60Hz				
		Main output(Comparative value output)				
	N	Indication type only				
⑤ Output	1	Relay first-stage(High-limit) output + NPN open collector output				
	2	Relay two-stage(High/Low-limit) output + NPN open collector output				

Specifications

	MP5M-4N	MP5M-41	MP5M-42
Model	Indication	High-limit setting	High/Low-limit setting
Power supply	100-240VAC 50/60Hz		
Allowable operation voltage	90 to 110% of rated voltage		
Power consumption	Approx. 7.5VA(240VAC)	Approx. 8VA(240VAC)	
Power for external sensor	12VDC ±10%, 80mA		
Measuring accuracy (23 ±5°C)	• Mode F1, F4, F7, F8 : F.S. ±0.05% rdg ±1Digit • Mode F2, F3, F5, F6 : F.S. ±0.01% rdg ±1Digit		
Measuring range	• Mode F1, F4, F7, F8 : 0.0005Hz to 50kHz • Mode F3 : 0.02s to 3,200s • Mode F2, F5, F6 : 0.01s to 3,200s • Mode F9, F10, F11 : 0 ~ 4 × 10 ⁹ Count		
Input frequency	• Solid state input : Max. 50kHz(Pulse width:Min. 10μs) • Contact input : Max. 45Hz(Pulse width:Min. 11ms)		
Input level	[Voltage input] High : 4.5-24VDC, Low : 0-1VDC, Input impedance : 4.5kΩ [No-voltage input] Short-circuit impedance : Max. 300Ω, Residual voltage : Max. 1V, Open-circuit impedance : Min. 100kΩ		
Max. indication	5Digit(0.0001 to 99999)		
Display method	7 Segment LED(Zero Blanking), Display Size : W4×H8mm		
Display accuracy	0.05 / 0.5 / 1 / 2 / 4 / 8sec.(The same as update output cycle)		
Operation mode	Number of revolution/Speed/Frequency(F1), Passing speed(F2), Cycle(F3), Passing time(F4), Time width(F5), Time difference(F6), Absolute rate(F7), Density(F8), Length measurement(F9), Interval(F10), Integration(F11)		
Prescale function	Direct input method(0.0001 × 10 ⁻⁹ to 9.999 × 10 ⁹)		
Hysteresis	0 to 9999		
Other functions	• Lock setting function • Auto-Zero time setting function • Time unit selection function • Display value monitoring function • Memory retention function(Mode F11 applied only)	• Lock setting function • Monitoring delay function • Auto-Zero time setting function • Time unit selection function • Display value monitoring function • Memory retention function(Mode F11 applied only) • Comparative output function(H)	• Lock setting function • Monitoring function • Auto-Zero time setting function • Time unit selection function • Display value monitoring function • Memory retention function(Mode F11 applied only) • Comparative output function(H, L) • Output mode selection function(S, H, L, B, I, F) • Deviation memory function(F output mode)
Main output	High-limit setting Relay output NPN open collector output	250VAC 3A resistive load 1a 1b 30VDC 100mA max.	250VAC 3A resistive load 1a × 2 30VDC 100mA max. × 2
Memory	Non-volatile memory(Input times : 100,000 times)		
Insulation resistance	Min. 100MΩ(Standard 500VDC) between terminal and case		
Dielectric strength	2000VAC 60Hz 1minute(Between terminals of AC power and case, Between terminals of AC power and measuring terminals)		
Impulse noise strength	±2000V the square wave noise(pulse width:1μs) by the noise simulator R/S phase, repetition frequency 60Hz		
Vibration	Mechanical	0.75mm amplitude at frequency of 10 to 55Hz in each of X, Y, Z directions for 2 hour	
	Malfunction	0.5mm amplitude at frequency of 10 to 55Hz in each of X, Y, Z directions for 10 minutes	
Shock	Mechanical	300m/s ² (Approx. 30G) 3 times at X, Y, Z direction	
	Malfunction	100m/s ² (Approx. 10G) 3 times at X, Y, Z direction	
Relay life cycle	Mechanical	Min. 10,000,000 operations	
	Electrical	Min. 100,000 times at 250VAC 3A(resistive load)	
Ambient temperature	-10 to 50°C(at non-freezing status)□		
Storage temperature	-20 to 60°C(at non-freezing status)□		
Ambient humidity	35 to 85%RH		
Weight	Approx. 275g	Approx. 310g	Approx. 330g

Dimensions

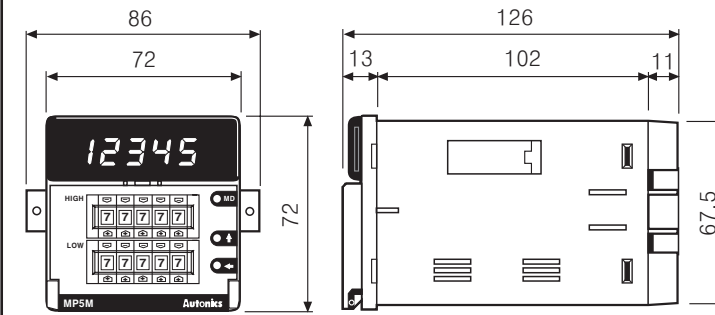

● Panel cut-out

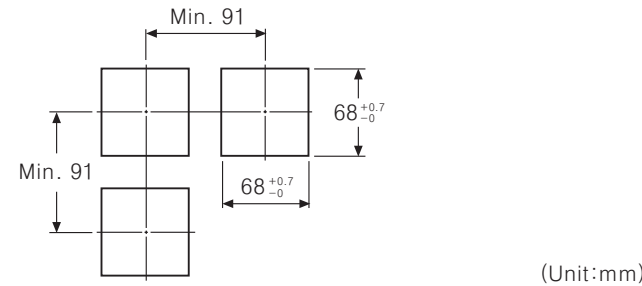

Connection

● High-limit setting(MP5M-41)

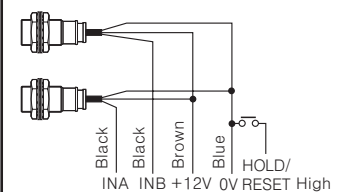

● High/Low-limit setting(MP5M-42)

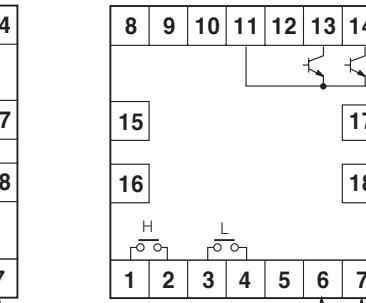
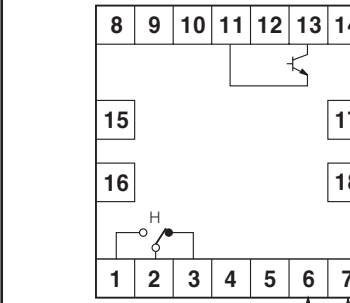
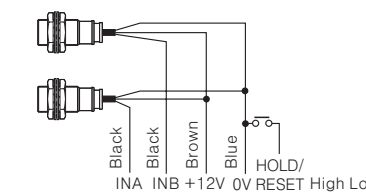

● Indication(MP5M-4N)

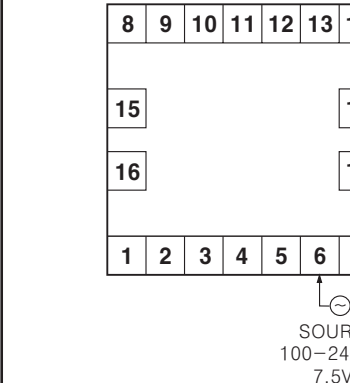
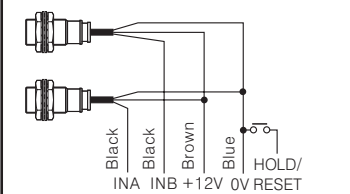

Input · Output

● Input specification

- Input signal
 - Solid state input
 - Input frequency: 50kHz(Max.)
Standard duty rate of input signal is 1:1, ON/OFF pulse width should be each over 10μs.
 - Input voltage Level : ON voltage→4.5-24V, OFF voltage→0-1.0V
- Relay contact input
 - Input frequency : 45Hz(Max.)
ON/OFF pulse width should be each over 11ms.
 - Relay contact specification : Please use a contact that can switch reliably at 12VDC, 2mA min. of load current.

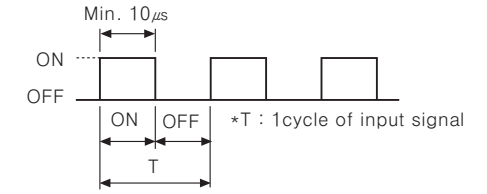

2. Input type

MP5M has **NPN input and PNP input** and it is able to select it in Parameter 1 group.

(1) NPN input type

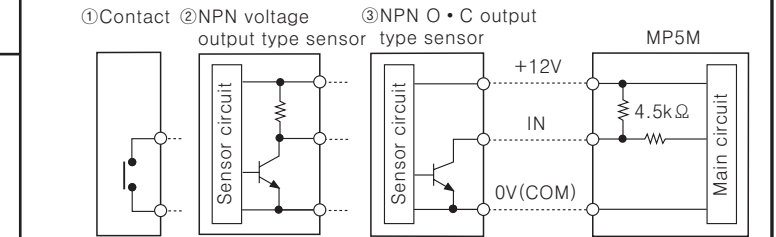

(2) PNP input type

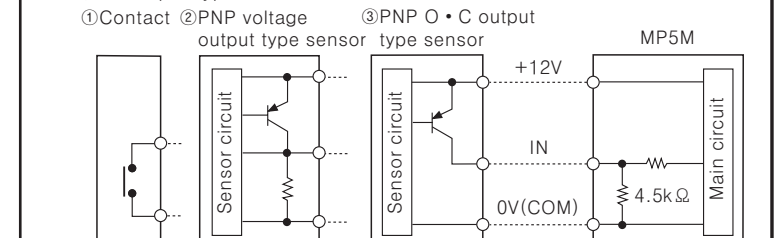

※ O · C is Open collector output

Operation mode

- Select operation mode from **modE**(mode) of Parameter 1 group.
- There are 11 kinds of operation mode.

● **Mode F1(Frequency/Number of revolution/Speed)**

- This mode is to display calculated frequency or number of revolution, speed by measuring frequency of Input A,
- Frequency(Hz) = $f \times \alpha$ ($\alpha = 1[\text{sec}]$)
 - Number of revolution(rpm) = $f \times \alpha$ ($\alpha = 60[\text{sec}]$)
 - Speed(m/min) = $f \times \alpha$ ($\alpha = 60L[\text{sec}]$)
 ※ L = The length of conveyor moved for 1 pulse cycle[m]

● Display value and display unit

Display value	Display unit	α (Prescale value)
Frequency	Hz	1
	kHz	0.001
Number of revolution	RPS	1
	rpm	60
Speed	mm / sec	1,000L
	cm / sec	100L
	m / min	60L
	km / hour	3.6L

※ Display unit of factory default : rpm

● Time chart

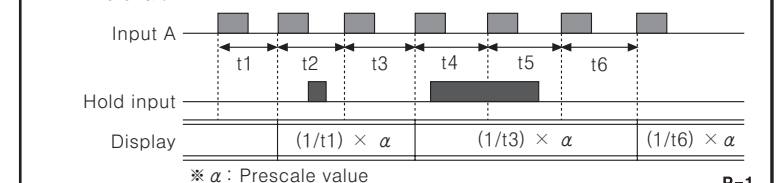

※ α : Prescale value

Mode F2(Passing speed)

It displays the passing speed between ON of input A and ON of input B.
 Passing speed(V) = $f \times \alpha$ ($\alpha = L[m]$)
 *f : This is reciprocal number of the time between ON of input A and ON of input B.
 L : The distance between input A and input B[m]

Display value and display unit

Display value	Display unit	α (Prescale value)
Passing speed	mm / sec	1,000L
	cm / sec	100L
	m / sec	L
	m / min	60L
	km / hour	3.6L

*Display unit of factory default : m/sec

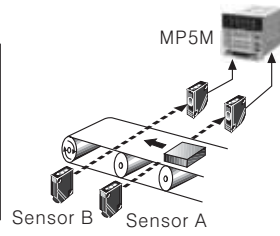

Time chart

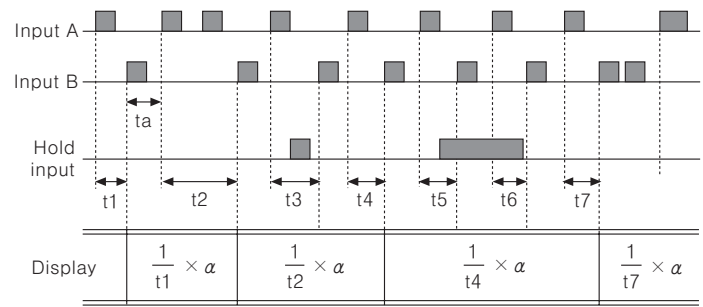

* α : Prescale value
 ta : It needs min. 20ms for return time

Mode F3(Cycle)

It displays the time from when input A is ON to the next ON of input A.
 Cycle(T) = t
 *t : Measurement time[sec]

Display value and display unit

Display value	Display unit
Cycle	SEC
	MIN
	999.99sec.
	9999.9sec.
	9999.9min.
	99999sec.
	99999min.

*Set the display unit at the **Unit**(Time unit) of Parameter 2.
 *Display unit of factory default : 999.99sec.

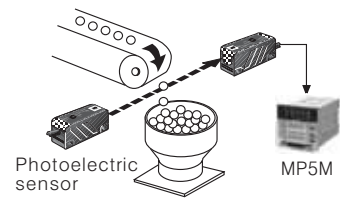

Time chart

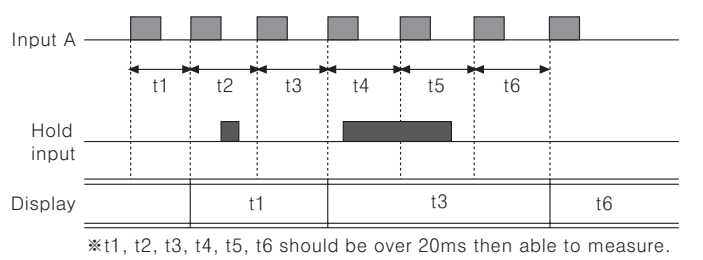

*t1, t2, t3, t4, t5, t6 should be over 20ms then able to measure.

Mode F4(Passing time)

It displays the passing time of certain distance as measuring the time between ON and the next ON of Input A.

$$\text{Passing time[sec]} = t \times \alpha \left(\alpha = \frac{L[m]}{\text{Moving distance within 1 pulse cycle[m]}} \right)$$

*t: Measurement time[sec], L: Certain distance[m]

Display value and display unit

Display value	Display unit
Passing time	SEC
	MIN
	999.99sec.
	9999.9sec.
	9999.9min.
	99999sec.
	99999min.

*Display unit of factory default : 999.99sec.
 *Set the display unit at the **Unit**(Time unit) of Parameter 2.

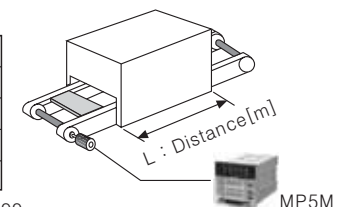

Time chart

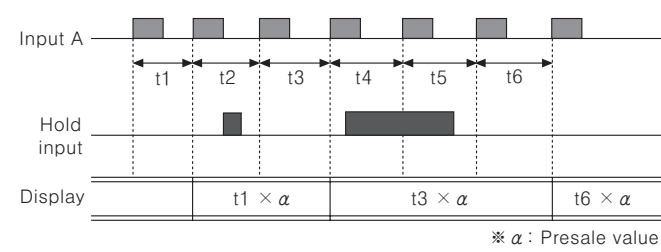

* α : Presale value

Mode F5(Time width)

It displays the ON time of input A.
 Time width[T] = t
 *t : ON measurement time of input A[sec]

Display value and display unit

Display value	Display unit
Passing time	SEC
	MIN
	999.99sec.
	9999.9sec.
	9999.9min.
	99999sec.
	99999min.

*Set the display unit at the **Unit**(Time unit) of parameter 2.
 *Display unit of factory specification : 999.99sec.

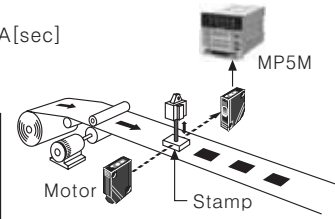

Timing charts

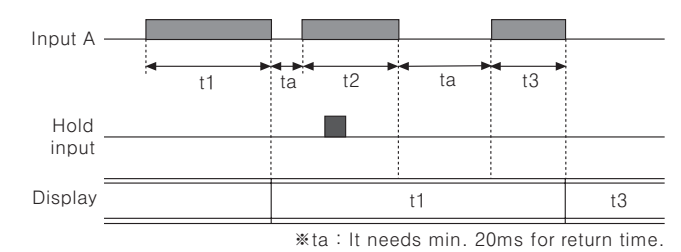

*ta : It needs min. 20ms for return time.

Mode F6(Time interval)

It displays the time from input A is ON to input B is ON.
 Time difference(T) = t(ta to tb)
 *t(ta to tb) : The measurement time from input A is ON to input B is ON[sec].

Display value and display unit

Display value	Display unit
Passing time	SEC
	MIN
	999.99sec.
	9999.9sec.
	9999.9min.
	99999sec.
	99999min.

*Display unit of factory default : 999.99sec.
 *Display unit can be set at **Unit**(Time unit) of Parameter 2.

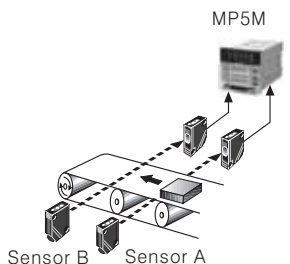

Time chart

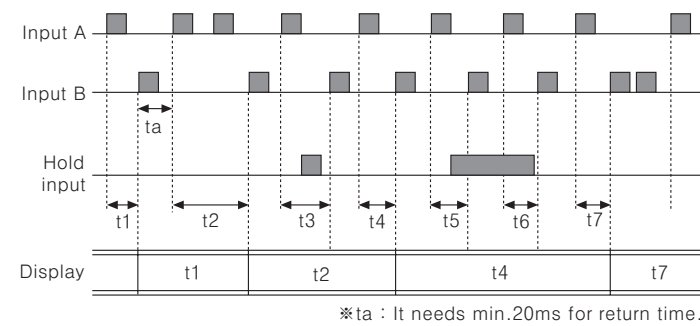

*ta : It needs min.20ms for return time.

Mode F7(Absolute rate)

It displays how many percentage(%) faster or late, speed, volume etc. of Input B against input A.
 Absolute rate = (Input B / Input A) × 100%

$$\text{Absolute rate} = \frac{\text{Frequency of input B[Hz]} \times B\alpha}{\text{Frequency of input A[Hz]} \times A\alpha} \times 100[\%]$$

Display value and display unit

Display value	Display unit
Absolute rate	%

*A α : Prescale value of input A
 B α : Prescale value of input B

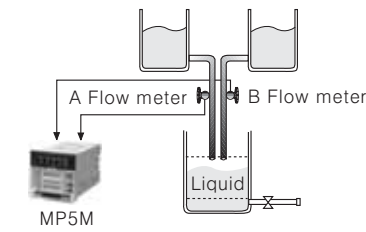

Time chart

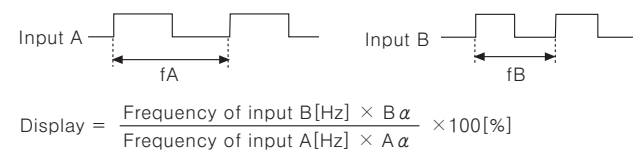

*Hold : Hold signal is ON, the display value will be held until Hold signal is OFF.

Mode F8(Error ratio)

It displays how many percentage(%) faster or late of Input B against Input A.

$$\text{Absolute rate} = \frac{\text{Input B} - \text{Input A}}{\text{Input A}} \times 100[\%]$$

$$\text{Error rate} = \frac{(\text{Frequency of input B[Hz]} \times B\alpha) - (\text{Frequency of input A[Hz]} \times A\alpha)}{\text{Frequency of input A[Hz]} \times A\alpha} \times 100[\%]$$

Display value and display unit

Display value	Display unit
Error rate	%

*A α : Prescale value of input A
 B α : Prescale value of input B

Timing chart

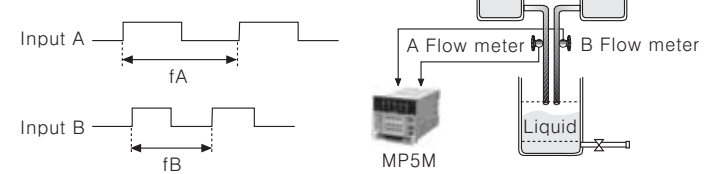

$$\text{Display} = \frac{(\text{Frequency of input B[Hz]} \times B\alpha) - (\text{Frequency of input A[Hz]} \times A\alpha)}{(\text{Frequency of input A[Hz]} \times A\alpha) + (\text{Frequency of input B[Hz]} \times B\alpha)} \times 100[\%]$$

*Hold : Hold signal is ON, the display value will be held until Hold signal is OFF.

Mode F9(Length measurement)

It displays the number of Input A pulse while Input B is ON.
 Length measurement = P × α
 (*P : Number of input A pulse, α : Prescale value)

Display value and display unit

Display value	Display unit
Length measurement	Quantity[EA]
	mm
	cm
	m

*Factory default(Unit) : Quantity[EA]

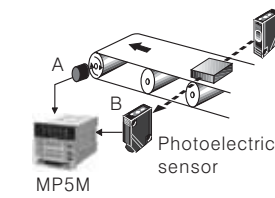

Time chart

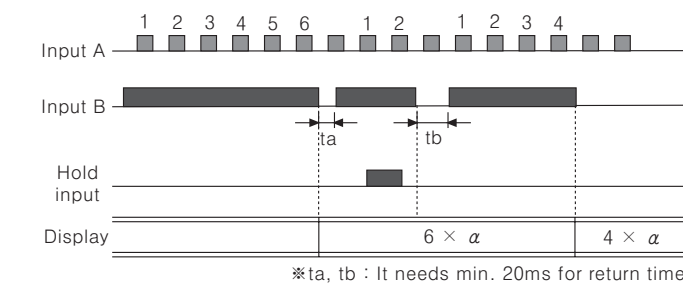

*ta, tb : It needs min. 20ms for return time

Mode F10(Interval)

It displays the number of Input A pulse from Input B is ON to the time Input B is ON next.
 Interval = P × α (*P : Number of input A pulse, α : Prescale value)

Display value and display unit

Display value	Display unit
Length measurement	Quantity[EA]
	mm
	cm
	m

*Factory default(Unit) : Quantity[EA]

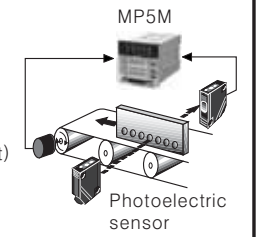

Time chart

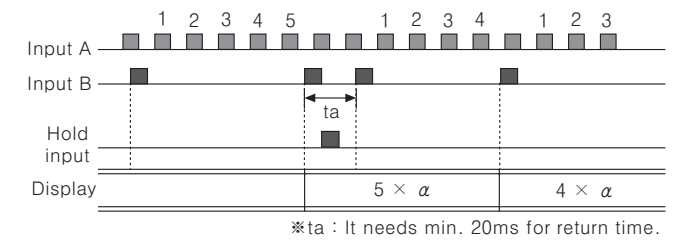

*ta : It needs min. 20ms for return time.

Mode F11(Integration)

It displays the counting value against pulses of Input A.
 Integration = P × α
 *P : Pulse number of input A, α : Prescale value

Display value and display unit

Display value	Display unit
Interval	Quantity[EA]

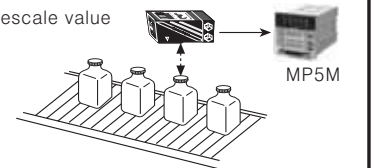

Operation and Time chart

① It counts the number of Input A pulse.
 ② As input B is an enable input signal it stops the counting and display value of input A when it is ON and then it counts input A continuously when it is OFF.

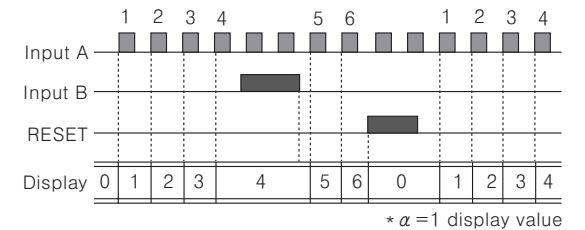

* α = 1 display value

Output mode

- Select output mode in **out-t**(Output type) of Parameter1 group.
- There are 2 stages output(H, L).
- There are 6 kinds of output mode such as S(Standard) output mode, H(High) output mode, L(Low) output mode, B(Block) output mode, I(One shot)output mode, F(Deviation)output mode.
- The setting value(H, L) should be L < H in B comparative output mode and it operates individually not related to the setting value(H, L) in others output mode(S, H, L, I).
- It is applied at MP5M-42 only. MP5M-41 is fixed in S output mode.

S(Standard) output mode[5t-std], B(Block) output mode[out-b]

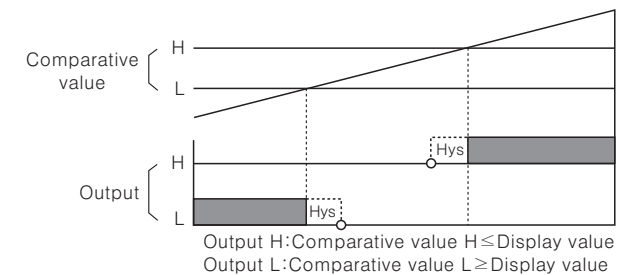

H(High) Output mode[out-h]

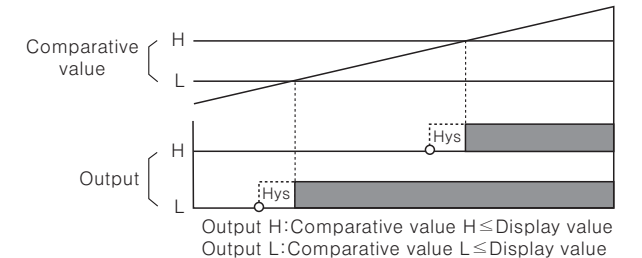

● L(Low) output mode[*out-L*]

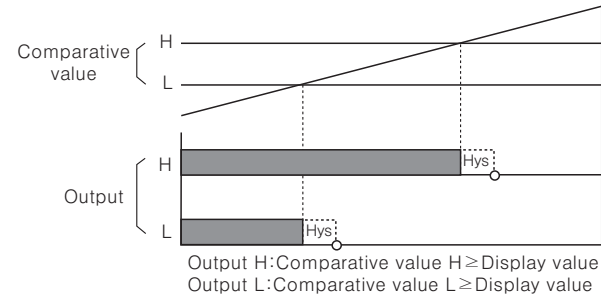

● I(One Shot) output mode[*out-I*]

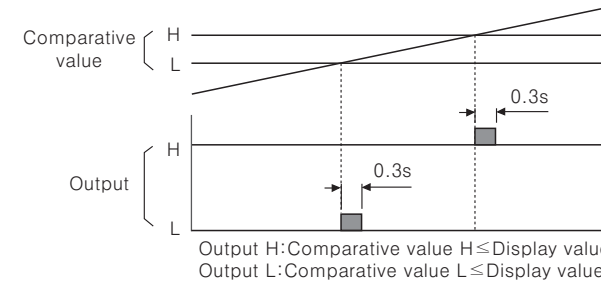

※One Shot(■) output time is fixed as 0.3sec.
※There is no Hysteresis in I(One shot) comparative output mode.

● F(Deflection) output mode[*out-F*]

This function is to memorize the setting value and provide outputs when it exceeds the deviation of H, L.

- The setting value memory : Memorize the current display value as the setting value by pressing (M+▲) key in front.
- Displays the setting value : Check the memorized the setting value by (▲) key.
- (It displays the memorized setting value for pressing ▲key continuously.)
- Deviation setting : Set H, L deviation by setting value.
- (The set deviation will be memorized until setting the next deviation again even though power off.)
- Deviation setting range : 0.0001 to 99999(The setting range will be changed by decimal point setting parameter. If set decimal point as 0000.0, the setting range will be 0.1 to 9999.9.)
- Operation

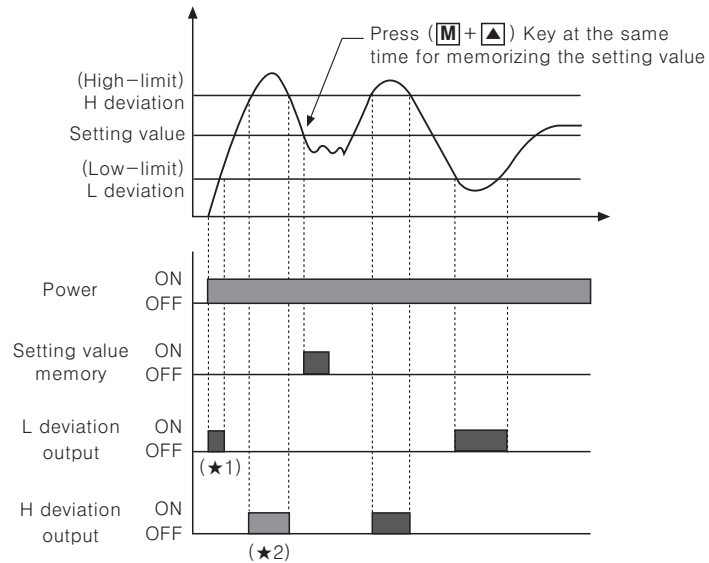

※(★1)When select the initial comparative output limit function, output will not be come out.
※(★2)Output position may be different from above graph.
※There are no HH, GO, LL outputs in F output mode.
※Even though you set the deviation as "0(Zero)", it will actually work as setting "1".

■ Operation chart by each Parameter group

●The display parameter are different by each operation mode, please see "Parameter" below.
●● : When select the operation mode, the parameter will be displayed.
X : When select the operation mode, the parameter will not be displayed.

●Parameter 0 group

Parameter 0	Sub mode	F1	F2	F3	F4	F5	F6	F7	F8	F9	F10	F11
h.PEK		●	●	●	●	●	●	●	●	●	●	X
L.PEK		●	●	●	●	●	●	●	●	●	●	X

●Parameter 1 group

Parameter 1	Sub mode	F1	F2	F3	F4	F5	F6	F7	F8	F9	F10	F11
mode		●	●	●	●	●	●	●	●	●	●	●
In-A		●	●	●	●	●	●	●	●	●	●	●
In-b		X	●	X	X	X	●	●	●	○	○	○
out-t		●	●	●	●	●	●	●	●	●	●	X
hyS		●	X	X	X	X	X	●	●	X	X	X
GuAr.d	F.dEFy	●	●	●	●	●	●	●	●	●	●	X
	StAr.t	●	●	●	●	●	●	●	●	●	●	X
Auto.A		●	X	X	●	X	X	●	●	X	X	X
Auto.b		X	X	X	X	X	X	●	●	X	X	X
mEmo		X	X	X	X	X	X	X	X	X	X	●

※"○": IN-b sensor will be set as nPnhF or PnPnHF type only in mode F9, F10, F11.

●Parameter 2 group

Parameter 2	Sub mode	F1	F2	F3	F4	F5	F6	F7	F8	F9	F10	F11
dot		●	●	X	X	X	X	●	●	●	●	●
t.unT		X	X	●	●	●	●	X	X	X	X	X
PSC.A.X(Notel)		●	●	X	●	X	X	●	●	●	●	●
PSC.A.y(Notel)		●	●	X	●	X	X	●	●	●	●	●
PSC.b.X		X	X	X	X	X	X	●	●	X	X	X
PSC.b.y		X	X	X	X	X	X	●	●	X	X	X
dISP.t		●	X	X	X	X	X	●	●	X	X	X

※(Notel)PSC. X, PSC. y are displayed in mode F1, F2, F4, F9, F10, F11.

●Parameter 3 group

Parameter 3	Sub mode	F1	F2	F3	F4	F5	F6	F7	F8	F9	F10	F11
LoC		●	●	X	X	X	X	●	●	●	●	●

●Monitoring delay operation function chart by each output mode

	out-t	StAr.d	out-h	out-L	out-b	out-I	out-F
Comparative output adjustment function.	●	X	X	●	X	●	●
Starting correction timer function	●	●	●	●	●	●	●

■ Parameter

●Parameter 0 group

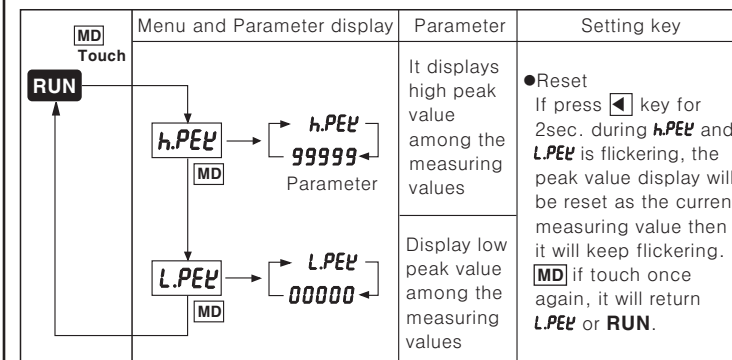

※If press MD key in RUN it will enter into h.PEV.
※If pressing MD key for 2sec. in all setting, data will be saved then return to RUN mode. If no key is touched for 60sec. data will be held as previous value and return to RUN mode.
※When entering into parameter 0 the parameter name and data will be flickering by 1sec..
※It will show the set data to flicker by 1sec., then move to next Parameter with touching MD key once.

●Parameter 1 group

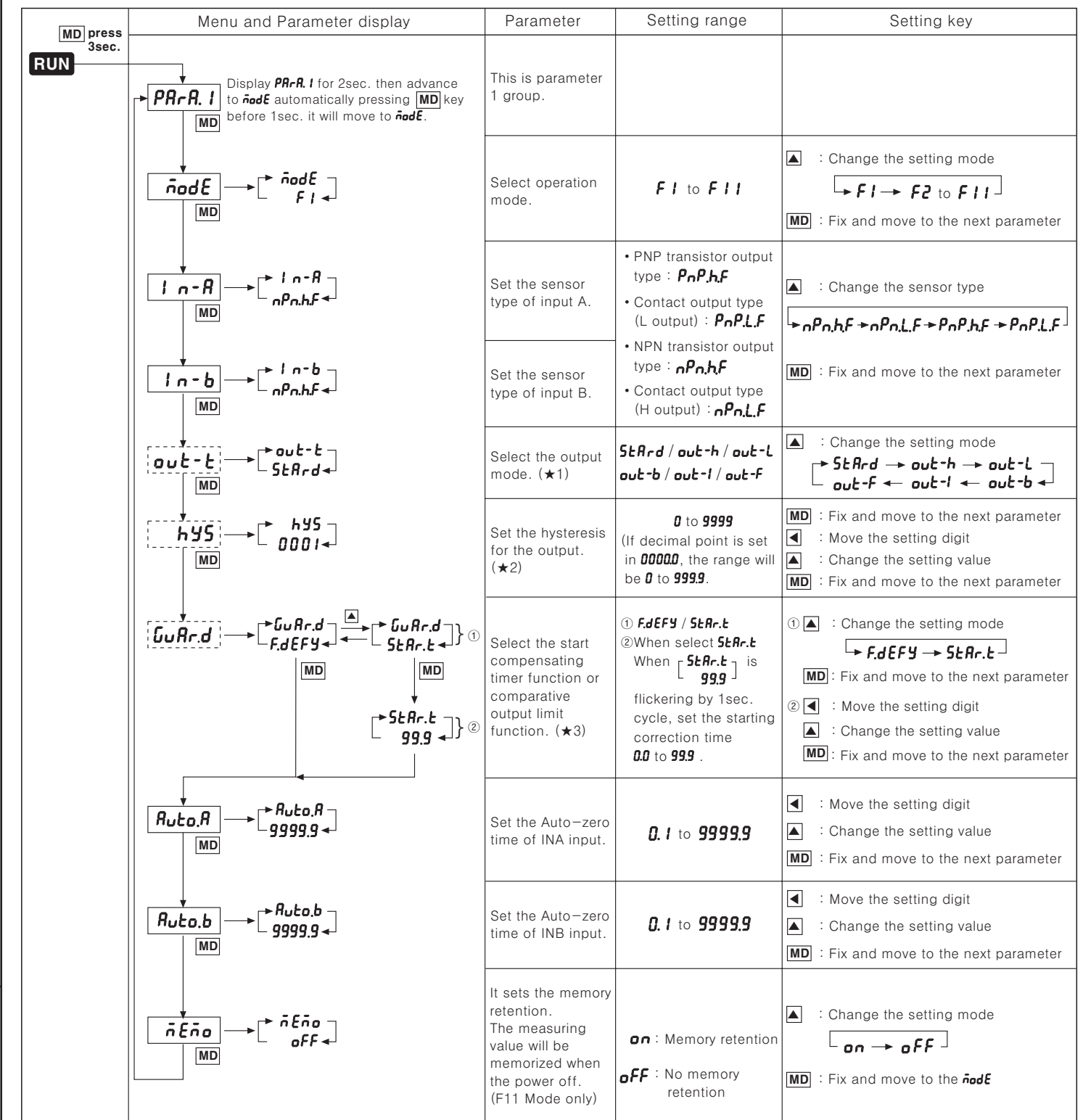

※If you press MD key for 3 sec. in RUN, it will enter into parameter 1 group.
※The output mode is fixed as out-h type in F11 operation mode.
※(★1) is not shown is MP5M-41 and indicate type. But, MP5M-41 is fixed by S output mode. Output mode out-h type in F11 mode of MP5M-42 is fixed.
※(★2)Hysteresis operation mode is able to be set in F1, F7 to F8 operation mode.
※(★3)It is able to select the comparative output [F.dEFY] limit function or starting correction [StAr.t] timer in monitoring delay function mode [GuAr.d].
When select the comparative output limit [F.dEFY] function, it will move to the next parameter [Auto.A] and when select the starting correction time [StAr.t] you need to be set the starting correction time [0.0 ~ 999] so that it moves to the next parameter [Auto.A].
When entering into parameter 1 group, the parameter name and data will be flickering by 1 sec. then move setting digit by ◀key or change the setting value by ▲key.
※All data set by users will be shown[displayed] to 1sec. cycle then move to the next parameter by pressing MD key.
※ [] parameter is not shown in MP5M-4N, MP5M-41. But, [hys] at [] parameter is shown in MP5M-41.

●Parameter 2 group

Menu and Parameter display	Parameter	Setting range	Setting key								
<p>MD Press for 4sec. RUN</p> <p>Display PR-A.2 for 2sec. then advance to dot automatically pressing MD key before 1sec. it will move to dot.</p> <p>dot (★1)</p> <p>t.unt → t.SEC → t.nin</p>	This is parameter 2 group.										
<p>dot</p> <p>t.unt → t.SEC → t.nin</p>	Set decimal point position of display value	<p>00000 00.000</p> <p>0000.0 0.0000</p> <p>000.00 0.0000</p>	<p>◀ : Move the setting digit</p> <p>MD : Fix and move to the next parameter</p>								
<p>t.unt → t.SEC → t.nin</p> <p>① Select the time unit</p> <p>② Select the time range</p>	It will be displayed in F3, F4, F5, F6 operation mode and set the time unit. (★1)	<table border="1"> <thead> <tr> <th>SEC</th> <th>MIN</th> </tr> </thead> <tbody> <tr> <td>999.99sec.</td> <td>999.99min.</td> </tr> <tr> <td>9999.9sec.</td> <td>9999.9min.</td> </tr> <tr> <td>99999sec.</td> <td>99999min.</td> </tr> </tbody> </table>	SEC	MIN	999.99sec.	999.99min.	9999.9sec.	9999.9min.	99999sec.	99999min.	<p>① ▲ : Change the setting mode</p> <p>▶ t.SEC → t.nin</p> <p>MD : Save</p> <p>② ▲ : Change the setting value</p> <p>▶ 999.99 → 9999.9 → 99999</p> <p>MD : Fix and move to the next parameter</p>
SEC	MIN										
999.99sec.	999.99min.										
9999.9sec.	9999.9min.										
99999sec.	99999min.										
<p>PSC.AH</p> <p>PSC.AY</p> <p>PSC.bH</p> <p>PSC.bY</p> <p>di SP.t</p>	Set the prescale value of input A mantissa(X).	00000 to 9.9999	<p>◀ : Move the setting digit</p> <p>▲ : Change the setting value</p> <p>MD : Fix and move to the next parameter</p>								
	Set the prescale value of input A an exponent(y).	10 - 9 to 10 9 (10 ⁻⁹ to 10 ⁹)	<p>◀ : Move the setting digit</p> <p>▲ : Change the setting value</p> <p>MD : Fix and move to the next parameter</p>								
	Set the prescale value of input B mantissa(X).	00000 to 9.9999	<p>◀ : Move the setting digit</p> <p>▲ : Change the setting value</p> <p>MD : Fix and move to the next parameter</p>								
	Set the prescale value of input B an exponent(y).	10 - 9 to 10 9 (10 ⁻⁹ to 10 ⁹)	<p>◀ : Move the setting digit</p> <p>▲ : Change the setting value</p> <p>MD : Fix and move to the next parameter</p>								
	Select the display cycle.	0.05, 0.5, 1, 2, 4, 8	<p>▲ : Change setting value</p> <p>▶ 0.05 → 0.5 → 1</p> <p>▶ 8 ← 4 ← 2</p> <p>MD : Fix and move to the dot.</p>								

- It will enter into parameter 2 if pressing **MD** key for 4sec. in **RUN** mode.
- (★1) It is able to select second [t.SEC] or minute [t.nin] in time until selection parameter [t.un] then also selectable time range.
- When entering into the parameter 2 group, the parameter will flicker by 1sec. cycle then move the setting digit by **◀** key and change the setting value by **▲** key.
- The fixed data value set by user in each parameter will flicker by 1sec. cycle and move to the next parameter by pressing **MD** key. If you press **MD** key for over 2sec. in every setting mode data will be set and return to **RUN**.

●Parameter 3 group

Menu and Parameter display	Parameter	Setting range	Setting key
<p>MD Press for 5sec. RUN</p> <p>Display PR-A.3 for 2sec. then move to LoC automatically. Move to LoC, if press MD key before 1sec.</p> <p>LoC</p>	This is parameter 3 group.		
<p>LoC</p>	Enable to lock the key for each parameter group	<p>oFF : There is no key lock in all mode</p> <p>LoC.0 : P0 to 3 Lock</p> <p>LoC.1 : P1 to 3 Lock</p> <p>LoC.2 : P2 to 3 Lock</p> <p>LoC.3 : P3 Lock only</p>	<p>▲ : Change the setting mode</p> <p>▶ oFF → LoC.0 → LoC.1</p> <p>▶ LoC.3 ← LoC.2</p> <p>MD : If pressing MD key for over 2sec., Data will be set and it will return to RUN.</p>

- It will enter into parameter 3 if pressing **MD** key for 5sec in **RUN** mode.
- When entering into the parameter 3 group the parameter name and data value will flicker by 1sec. cycle then change the setting value by **▲** key.
- The fixed data value by user in each parameter will flicker by 1sec. cycle and be set and return to **RUN** mode by pressing **MD** key for over 2sec. then if no key is touched for 60sec. data will be held as previous value and return to **RUN** mode.

■ Function

○ Prescale function



- How to set prescale value (α=15)
 Set prescale value (α) to separate as a mantissa(X) and an exponent(Y) at **PSC.AH**, **PSC.AY** (or **PSC.bH**, **PSC.bY**) of Parameter 2 group.
 Prescale value (α)=15 a Mantissa(X):1.5000, Exponent(y):01.
 And also it is able to set α value as X=0.015, Y=03 then get the same display value.
 *Display cycle can be selected at Parameter 2 group.

○ Display peak value monitoring function

- This is to monitor max. value and min. value by current display value and display that data at **h.PEV/L.PEV** mode of Parameter 0 group.
- User can check saved value in Parameter 0 group. And High Peak (**h.PEV**) or Low Peak (**L.PEV**) will be continuously saved during checking.
- See Parameter 0 for Reset.

○ Hysteresis function

- Set the Hysteresis value(A) for comparative setting value in order to prevent unstable operation due to output going ON/OFF frequently.

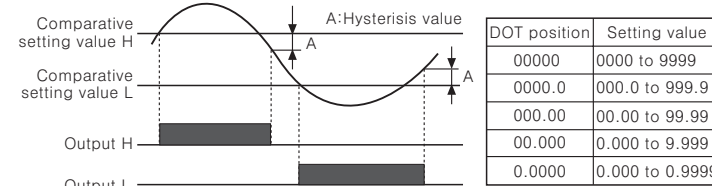

- You are able to set "0", but when set "0", the actual operation will be as "1".
- The initial setting value is 0001.
- You are able to set in the Parameter 1 group.

○ Monitoring delay time function

- This function is for the stable control to limit L, LL outputs until certain output is come or to limit all outputs during the equipment is reaching a stable status against various change of input such as the starting current when the motor is running after power on. There are the starting correction timer function and comparative output limit function in the monitoring delay time function. (Select at **GuAr.d** mode of parameter 1 group)
- The starting correction timer function (**StAr.t** mode of Parameter 1 group)
 This function is to make the output not come out during the setting time. (Time setting range 0.0 to 99.9sec.)

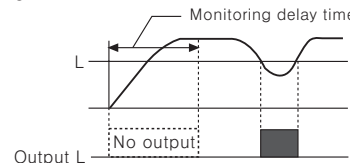

- Comparative output limit function (**F.dEFY** mode of Parameter 1 group)
 This function is to limit the L output before the H output of S, B, F output mode.

1) The output mode is S output mode, B output mode

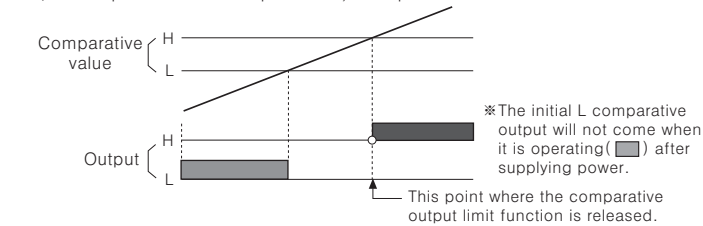

2) The output mode is F output mode

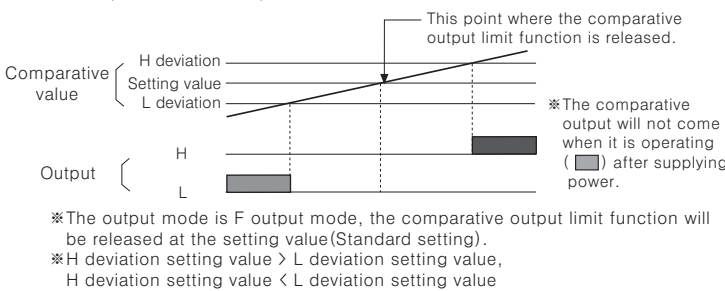

○ Auto-Zero time setting function

- When you know the interval of input signal, Auto-zero time should be set as a little bit longer than that interval of input signal. If there is no pulse input within setting time (Auto-zero time), it regards as the input signal is cut off then make the value as "00000" forcibly. Note that the Auto-zero time setting should be longer than the narrowest interval of input pulse. Otherwise it may be difficult to make the display value as "00000".
- Auto-zero time setting range (0.1 to 9999.9sec)
- When the display value is "00000", each output will be come against "0".

○ DIP switch cover detachment

Please turn off the power before detaching the cover.

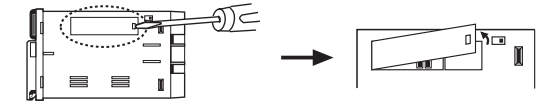

Push a lock part to front direction and widen it simultaneously.
 *Be careful in order not to be wounded.

○ Lock setting function

This function is to set the enable or disable of each Parameter and mode changes in MP5M.

- Off : Unlock
- LoC 0 : P0 to P3 Lock (Lock from Parameter 0 to Parameter 3)
- LoC 1 : P1 to P3 Lock (Lock from Parameter 1 to Parameter 3)
- LoC 2 : P2 to P3 Lock (Lock from Parameter 2 to Parameter 3)
- LoC 3 : P3 Lock (Lock Parameter 3 only)
- *Lock setting is available in Parameter 3 group.

○ Inner hardware Lock setting function

This function is to lock **LoC** in Parameter 3 group by Inner hardware Lock function in order to prevent wrong setting.

SW1	Inner hardware Lock setting
ON 1 2	h0 (Hardware Lock 0) : Enable to check and change the LoC mode of parameter 3 group.
OFF 1 2	h1 (Hardware Lock 1) : Enable to check the LoC mode only in parameter 3 group. But it is not possible to change the parameter.
ON 1 2	h2 (Hardware Lock 2) : Disable to check and change the LoC mode of parameter 3 group.
OFF 1 2	

*It is possible to lock or unlock after supplied power in Inner hardware Lock setting.

○ Display cycle selection function

This function is to change the display cycle in range of 0.05/0.5/1/2/4/8 sec., and displays the average value of measuring value for the setting cycle.

○ Time unit selection function

Enable to display PV value with firmed time unit in range of various time.

- Time unit selection function can be set in parameter 2 group.
- Applicable mode : Mode 3 to 6
- There is no DOT setting mode when set the time unit display function.

○ Factory default

Parameter 3 group		Parameter 2 group		Parameter 1 group	
Mode	Setting value	Mode	Setting value	Mode	Setting value
LoC	oFF	dot	00000	PSC.y	10 01
		PSC.x	1.0000	di SP.t	005
		h0	oFF	h1	oFF
		h2	oFF	h3	oFF

*The specification may not be displayed due to the operation mode and output specification.

■ Caution for using

- Installation environment
 - It shall be used indoor
 - Pollution Degree 2
 - Altitude Max. 2000m
 - Installation Category II.
 - Please use separated line from high voltage line or power line in order to avoid inductive noise.
 - Please install power switch or circuit breaker in order to cut the power supply.
 - The switch or circuit breaker should be installed near by users for safety.
 - Do not use this unit at below places.
 - Place where there are severe vibration or impact.
 - Place where there are direct ray of the sun.
 - Place where strong magnetic field or electric noise are generated.
 - Storage method
 When storing this unit for a long time, please avoid the direct ray of the sun and keep this unit under circumstances as -20 to +60°C, 35 to 85RH.
 - Fiber line : Shield wire must be used when the measuring input line is getting longer or there are lots of noises.
 - Please put enough space between power line and terminal of measuring input.
- *It may cause malfunction if above instructions are not followed.

■ Main products

- COUNTER
- TIMER
- TEMPERATURE CONTROLLER
- PANEL METER
- TACHO/LINE SPEED/PULSE METER
- DISPLAY UNIT
- PROXIMITY SENSOR
- PHOTOELECTRIC SENSOR
- FIBER OPTIC SENSOR
- PRESSURE SENSOR
- ROTARY ENCODER
- SENSOR CONTROLLER
- POWER CONTROLLER
- STEPPING MOTOR & DRIVER & CONTROLLER
- LASER MARKING SYSTEM (CO₂, Nd:YAG)

Autonics Corporation
<http://www.autonics.com>

Satisfiable Partner For Factory Automation

■ HEADQUARTERS :
 41-5, Yongdang-ni, Ungsang-eup, Yangsan-si, Gyeongnam, 626-847, Korea

■ INTERNATIONAL SALES :
 Bldg. 402 3rd Fl., Bucheon Techno Park, 193, Yakdae-dong, Wonmi-gu, Bucheon-si, Gyeonggi-do, 420-734, Korea
 TEL: 82-32-329-0722 / FAX: 82-32-329-0728

■ E-mail : sales@autonics.net