

TZN/TZ SERIES

Dual PID auto tuning controller

■ Features

- Dual PID auto tuning function :
High-speed response of PID control to reach to the desired value fast, low-speed of response of PID control to minimize the overshoot even though response is a little bit slow.
- High display accuracy :
±0.3% (by F · S value of each input)
- 2-Steps auto tuning control function
- Multi-input function (13 kinds of multi-input selection function) :
Temperature sensor, voltage and current selection function.
- Various sub output function :
Includes in LBA, SBA, 7kinds of alarm output and 4 kinds of alarm option function, PV transmission output (DC4-20mA), RS485 communication output
- Display the decimal point for analog input



⚠ Please read "Caution for your safety" in operation manual before using.



■ Ordering information





TZ	4	M	—	1	4	R	
Item	Digit	Size	Sub output	Control output	Power supply (*1)	R	Relay output
						S	SSR output
						C	Current output(DC4-20mA)
						2	24VAC/24-48VDC
						4	100-240VAC 50/60Hz
						1	Event 1 output
						1	Event 1 output
						2	Event 1 + Event 2 output
						R	Event 1+PV transmission output(DC4-20mA)
						1	Event 1 output
						2	Event 1 + Event 2 output
						R	Event 1+PV transmission output(DC4-20mA)
A	Event 1 + Event 2 + PV transmission output(DC4-20mA)						
T	Event 1+RS485 communication output						
B	Event 1+Event 2+RS485 communication output						
S	DIN W48×H48mm (Terminal block type)						
SP	DIN W48×H48mm (Plug type)						
ST	DIN W48×H48mm (Terminal block type)						
M	DIN W72×H72mm						
W	DIN W96×H48mm						
H	DIN W48×H96mm						
L	DIN W96×H96mm						
4	4 Digit						
TZ	Temperature PID						
TZN	Temperature PID New Type						

(*1) Only for TZ4SP, TZ4ST, TZ4L, TZN4M Series.

Dual PID Auto Tuning Controller

Specifications

*A blacked() item is upgraded function.

Series	TZ4SP TZN4S	TZ4ST	TZ4M TZN4M	TZ4W TZN4W	TZ4H TZN4H	TZ4L TZN4L
Power supply	100-240VAC 50/60Hz, 24VAC 50/60Hz / 24-48VDC					
Allowable voltage range	90~110% of power supply					
Power consumption	Approx. 5VA		Approx. 6VA(Low voltage type ☞ AC:Approx. 8VA, DC:Approx. 7W)			
Display method	7Segment LED Display 【Process value(PV) : Red, Setting value(SV) : Green】					
Character size	TZ4SP ☞ W4.8×H7.8mm TZN4S ☞ PV:W7.8×H11mm SV:W5.8×H8mm	W4.8×H7.8mm	TZ4M ☞ PV:W9.8×H14.2mm SV:W8×H10mm TZN4M ☞ PV:W8×H13mm SV:W5×H9mm	W8×H10mm	TZ4H ☞ W3.8×H7.6mm TZN4H ☞ PV:W7.8×H11mm SV:W5.8×H8mm	PV:W9.8×H14.2mm SV:W8×H10mm
Input	Thermocouple	K(CA), J(IC), R(PR), E(CR), T(CC), S(PR), N(NN), W(TT) <Tolerance of line resistance is max. 100Ω per a wire>				
	RTD	Pt100Ω, JIS Pt100Ω, 3wire <Tolerance of line resistance is max. 5Ω per a wire>				
	Analog	1-5VDC, 0-10VDC, DC4-20mA				
Control output	Relay	250VAC 3A 1c				
	SSR	12VDC ±3V 30mA Max.				
	Current	DC4-20mA Load 600Ω Max.				
Sub output	Transmission	———	PV transmission : DC4-20mA Load max. 600Ω			
	EVENT 1	———	250VAC 1A 1a			
	EVENT 2	———	250VAC 1A 1a			
	Communi- -cation	———	———	RS485(PV transmission, SV setting)		
Control type	ON/OFF control P, PI, PD, PIDF, PIDS					
Display accuracy	F.S ± 0.3% or 3℃ (Higher one)					
Setting type	Front push buttons					
Hysteresis	Adjustable 1~100℃ (0.1~100.0℃) at ON/OFF control					
Alarm output hysteresis	Adjustable ON/OFF 1~100 (0.1~100.0)℃ of alarm output					
Proportional band(P)	0.0 ~ 100.0%					
Integral time(I)	0 ~ 3600sec					
Derivative time(D)	0 ~ 3600sec					
Control time(T)	1 ~ 120sec					
Sampling period	0.5sec					
LBA setting	1 ~ 999sec					
RAMP setting	Ramp Up, Ramp Down at 1~99min.					
Dielectric strength	2000VAC 50/60Hz for 1min.					
Vibration	0.75mm amplitude at frequency of 10 ~ 55Hz in each of X, Y, Z directions for 2 hours					
Relay life cycle	Main output	Mechanical : Min. 10,000,000 times, Electrical : Min. 100,000 times(250VAC 3A resistive load)				
	Sub output	Mechanical : Min. 20,000,000 times, Electrical : Min. 300,000 times(250VAC 1A resistive load)				
Insulation resistance	Min. 100MΩ (at 500VDC mega)					
Noise	Square shaped noise by noise simulator (pulse width 1μs) ± 2kV					
Memory protection	Approx. 10years (When using non-volatile semiconductor memory)					
Ambient temperature	-10 ~ 50℃ (at non-freezing status)					
Storage temperature	-20 ~ 60℃ (at non-freezing status)					
Ambient humidity	35 ~ 85%RH					
Approval	   					
Unit weight	TZ4SP: Approx. 136g TZN4S: Approx. 150g	Approx. 136g	Approx. 270g	TZ4W: Approx. 270g TZN4W: Approx. 259g	Approx. 259g	Approx. 360g

*The low voltage is only for TZ4SP, TZ4ST, TZ4L, TZN4M series.

(A)
Counter

(B)
Timer

(C)
Temp.
controller

(D)
Power
controller

(E)
Panel
meter

(F)
Tacho/
Speed/
Pulse
meter

(G)
Display
unit

(H)
Sensor
controller

(I)
Switching
power
supply

(J)
Proximity
sensor

(K)
Photo
electric
sensor

(L)
Pressure
sensor

(M)
Rotary
encoder

(N)
Stepping
motor &
Driver &
Controller

(O)
Graphic
panel

(P)
Production
stoppage
models &
replacement

TZN/TZ Series

Connection

※RTD(Resistance Temperature Detector) : DIN Pt 100Ω (3-wire type), JIS Pt 100Ω (3-wire type)

※T.C(Thermocouple) : K, J, R, E, T, S, W, N

※In case of Analog input, please use T.C(Thermocouple) terminal and be careful about polarity.

●TZN4S

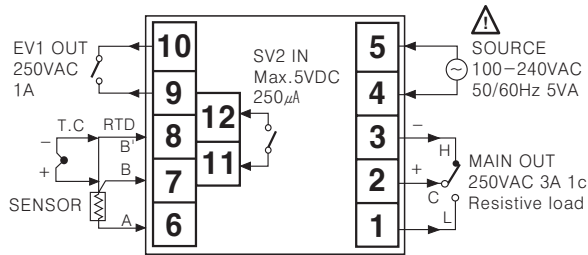

MAIN OUT	
SSR	Current
<p>12VDC ±3V 30mA Max.</p>	<p>DC4-20mA Load 600Ω Max.</p>

●TZN4M

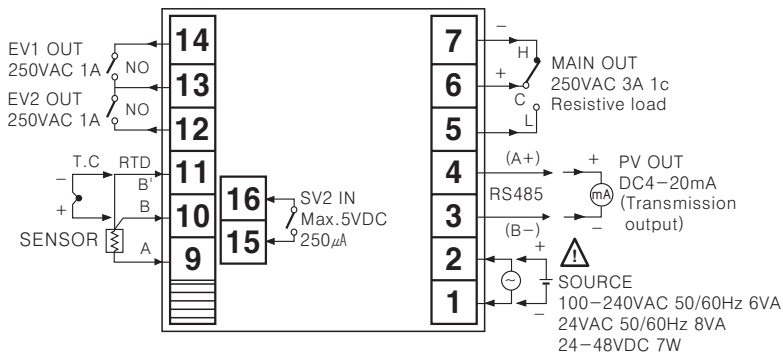

MAIN OUT	
SSR	Current
<p>12VDC ±3V 30mA Max.</p>	<p>DC4-20mA Load 600Ω Max.</p>

●TZ4SP

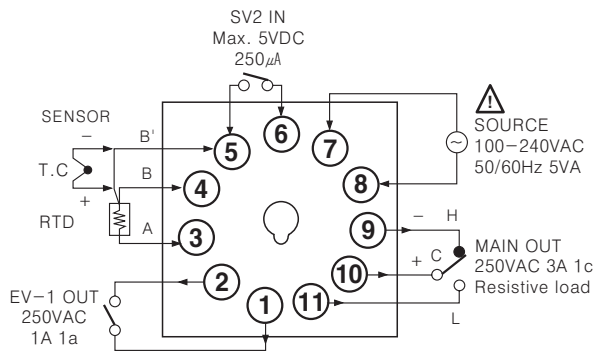

MAIN OUT	
SSR	Current
<p>12VDC ±3V 30mA Max.</p>	<p>DC4-20mA Load 600Ω Max.</p>

●TZ4ST

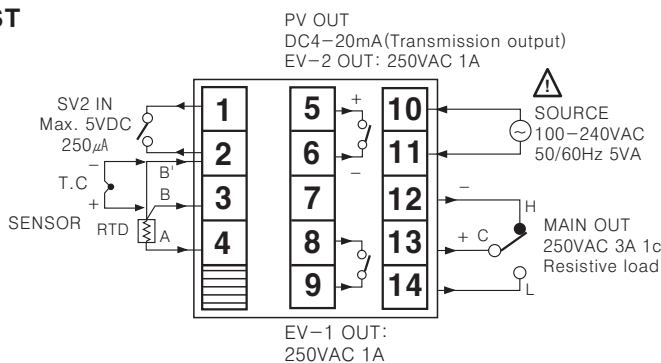

MAIN OUT		Sub output
SSR	Current	PV transmission output
<p>12VDC ±3V 30mA Max.</p>	<p>DC4-20mA Load 600Ω Max.</p>	<p>DC4-20mA Load 600Ω Max.</p>

●TZ4M

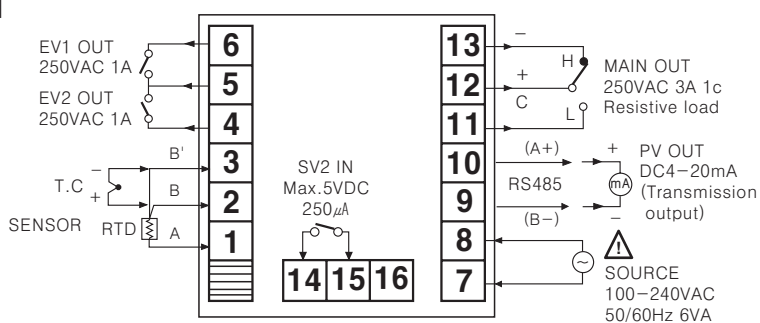

MAIN OUT	
SSR	Current
<p>12VDC ±3V 30mA Max.</p>	<p>DC4-20mA Load 600Ω Max.</p>

Dual PID Auto Tuning Controller

●TZ4W/TZN4W

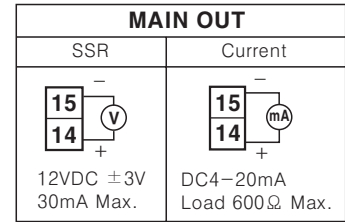
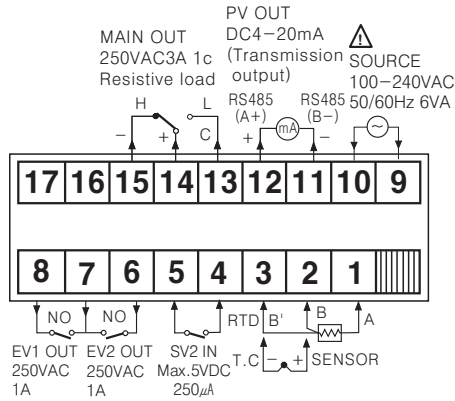

●TZ4H / TZN4H

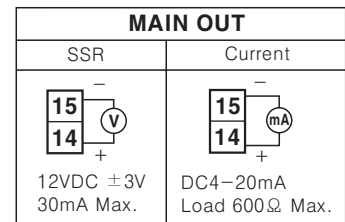
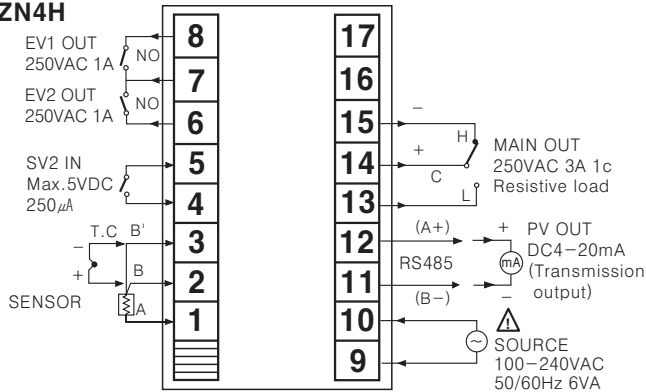

●TZ4L / TZN4L

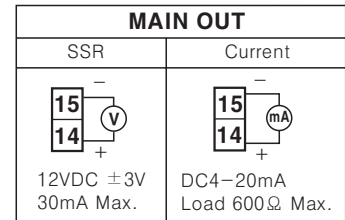
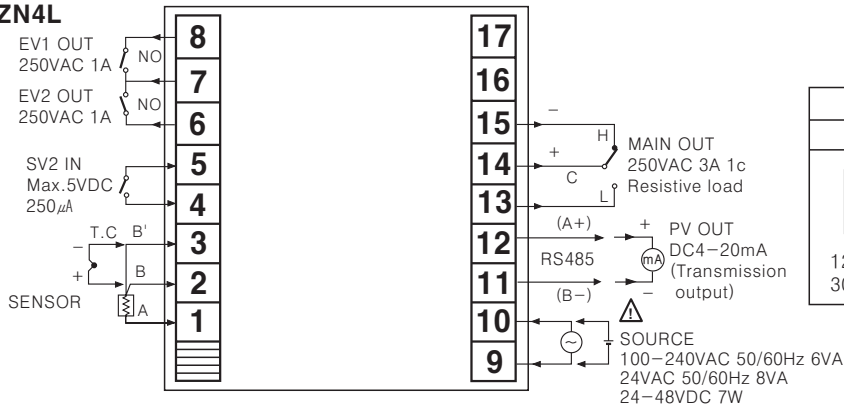

▣ Dimensions

●TZN4S

●Bracket

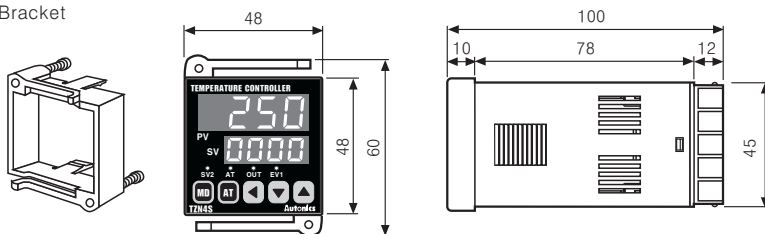

●Panel cut-out

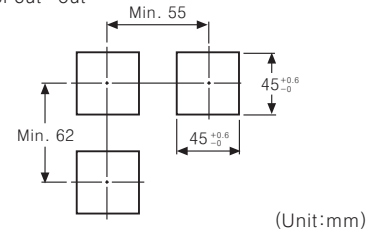

●TZN4M

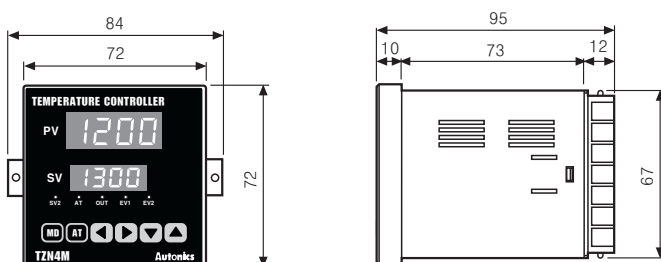

●Panel cut-out

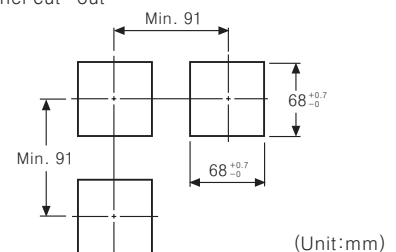

(A) Counter

(B) Timer

(C) Temp. controller

(D) Power controller

(E) Panel meter

(F) Tacho/Speed/Pulse meter

(G) Display unit

(H) Sensor controller

(I) Switching power supply

(J) Proximity sensor

(K) Photo electric sensor

(L) Pressure sensor

(M) Rotary encoder

(N) Stepping motor & Driver & Controller

(O) Graphic panel

(P) Production stoppage models & replacement

TZN/TZ Series

Dimensions

●TZ4SP

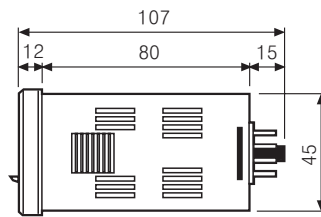
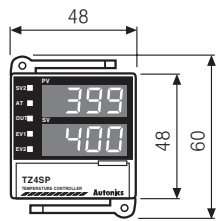

●Panel cut-out

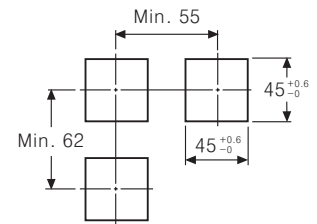

●TZ4ST

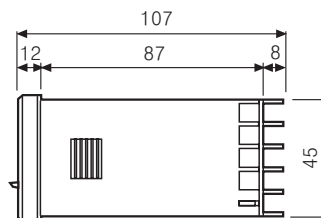
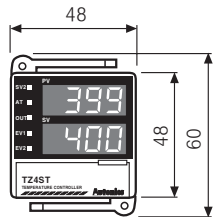

●Bracket

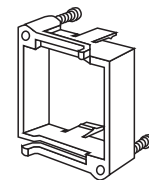

(Unit:mm)

※Since TZ4SP uses same identification plate with TZ4ST, the lamp does not work even though it has a EV2 output signal lamp.

●TZ4M

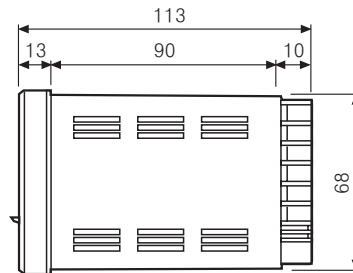
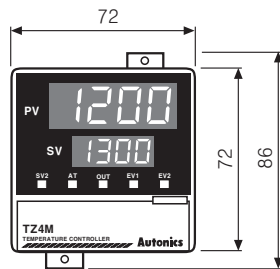

●Panel cut-out

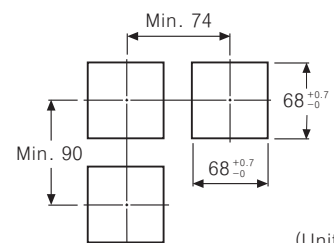

(Unit:mm)

●TZ4H

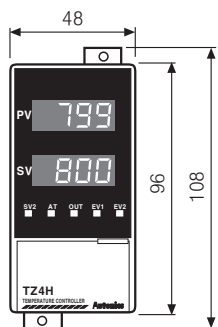

●TZN4H

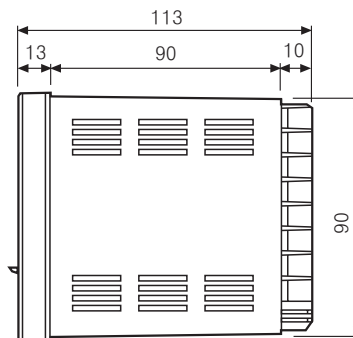
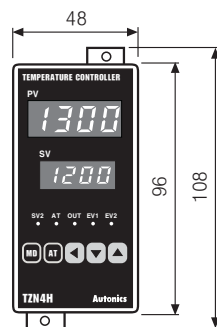

●Panel cut-out

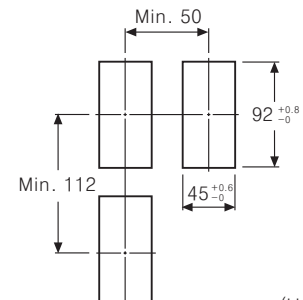

(Unit:mm)

●TZ4W

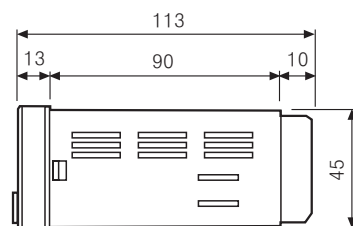
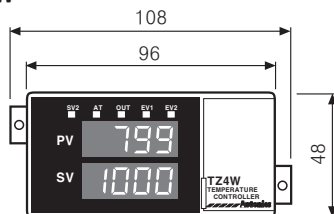

●Panel cut-out

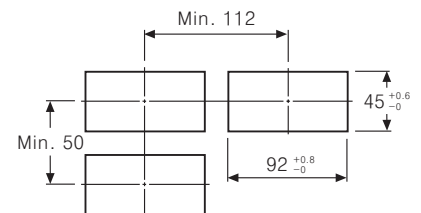

●TZN4W

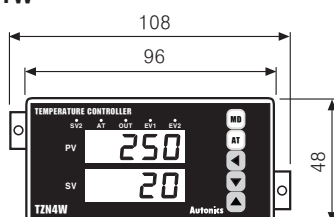

(Unit:mm)

Dual PID Auto Tuning Controller

●TZ4L

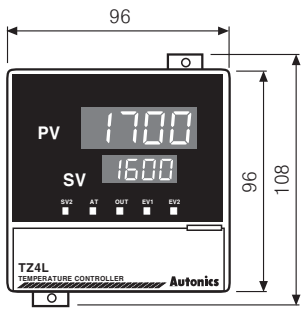

●TZ4N

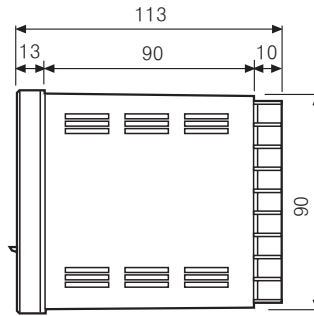
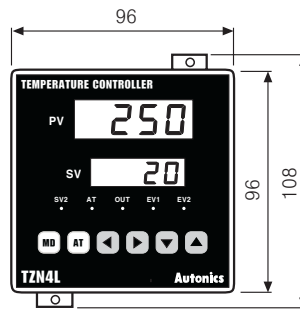

●Panel cut-out

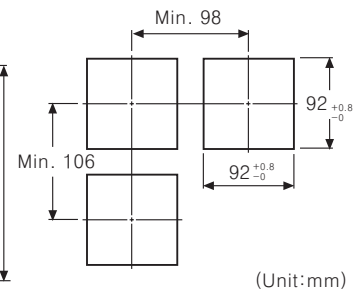

(Unit:mm)

(A) Counter
(B) Timer
(C) Temp. controller

■ Front panel identification

●TZ4S

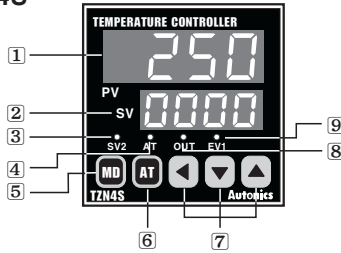

●TZ4M

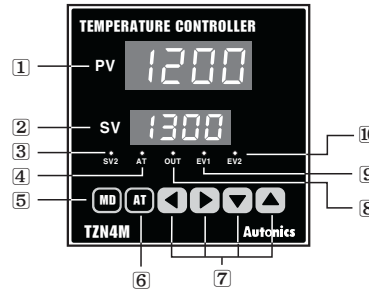

●TZ4ST/TZ4SP

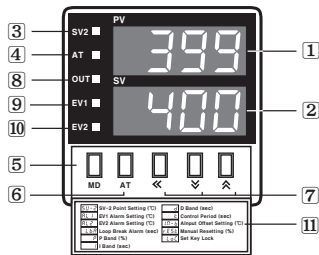

●TZ4M

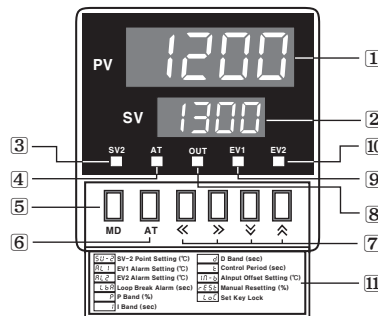

- ① : Display Processing value(Red)
- ② : Display Setting value(Green)
- ③ : Indicate SV2 operation
- ④ : Indicate Autotuning operation
- ⑤ : Mode key
- ⑥ : Autotuning operation key
- ⑦ : Setting keys
- ⑧ : Indicate control output operation
- ⑨ : Indicate EVENT 1 output
- ⑩ : Indicate EVENT 2 output
- ⑪ : Procedure of setting key

*Since TZ4SP uses same identification plate with TZ4ST, the lamp does not work even though it has a EV2 output signal lamp.
*There are no (▶, ⋙) Key in TZ4H and TZ4M.
*Control output indicator(OUT) does not work when it is used as current output type.

(D) Power controller
(E) Panel meter
(F) Tacho/ Speed/ Pulse meter
(G) Display unit
(H) Sensor controller
(I) Switching power supply
(J) Proximity sensor
(K) Photo electric sensor
(L) Pressure sensor

■ How to set and change the setting value(SV)

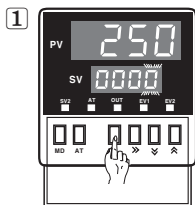

In case of changing the setting value at status of RUN, push ◀(◀◀) key. 10⁰ digit will flash at SV.

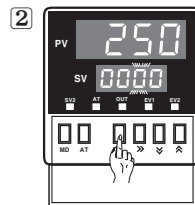

Push ◀(◀◀) key, and then the flash will be shifted step by step.

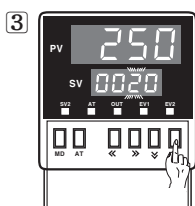
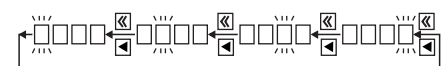

Push ▼(▼), ▲(▲) at the flash digit, and then change the setting value.

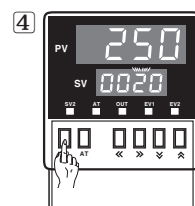

Push MD key when the setting is completed. It will stop flashing, then return to RUN mode.

*Above explanations are the example of TZ4M. In case of TZ series. Use the Key in brackets for setting (changing). There are no (▶, ⋙) Key in TZ4N, TZ4SP and TZ4ST. It is not used for setting or changing the setting value.

(M) Rotary encoder
(N) Stepping motor & Driver & Controller
(O) Graphic panel
(P) Production stoppage models & replacement

TZN/TZ Series

Flow chart for setting group 1

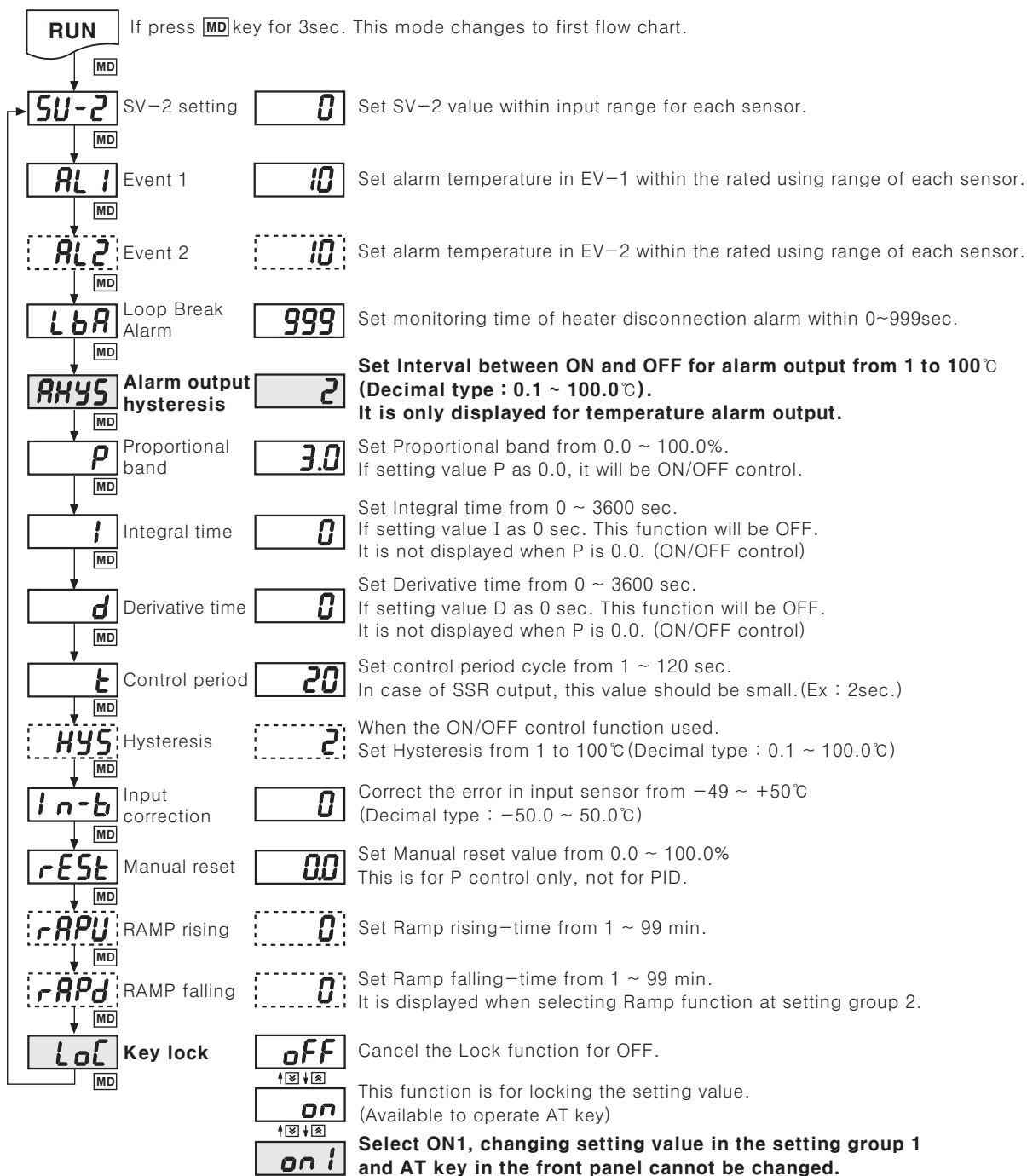

※ It will start to flash by pressing **◀**(◀◀) key and the flash will be moved by **◀**(◀◀), **▶**(▶▶) keys then set the value by **▲**(▲), **▼**(▼) keys. After that if pressing **MD** key the DATA will be changed then display next mode.

※ It returns to RUN status in case of pressing **MD** key for 3sec. after setting all mode to change.

※ If no key touched for 60sec., it will return to RUN mode automatically.

※ If not to set related mode in setting group 2, **AL1, AL2, LbA, I, d, t, HYS, rEst, rAPU, rAPd** mode will disappear and then jump to next mode.

Factory defaults(Setting group 1)

Mode	Setting value	Mode	Setting value	Mode	Setting value	Mode	Setting value
SU-2	0	ALHYS	2	t	20	rAPU	10
AL1	10	P	3.0	HYS	2	rAPd	10
AL2	10	I	0	In-b	0	LoC	off
LbA	600	d	0	rEst	0.0		

Dual PID Auto Tuning Controller

Flow chart for setting group 2

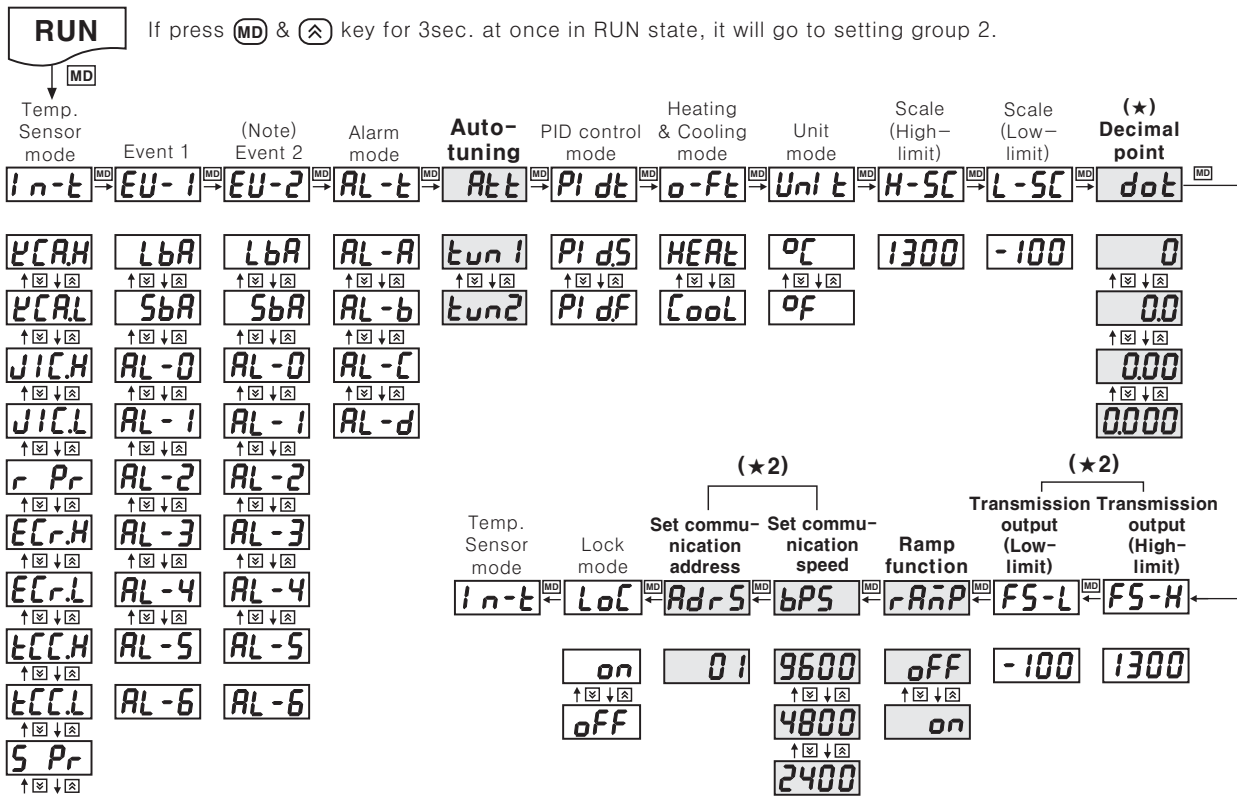

In-t	Input sensor : Select from 19 type	dot	Select decimal point position for Analog input
EU-1	Event 1 : Select from 9 type	FS-H	Set the high-limit scale value when retransmission output is applied. (20mA)
EU-2	Event 2 : Select from 9 type	FS-L	Set the low-limit scale value when retransmission output is applied. (4mA)
AL-t	Alarm output : Select from 4 type	rAnP	Able to set ON and OFF of Ramp function.
Ae.t	Auto-tuning : Selectable tun1 or tun2.	bPS	Set communication speed
Pi d.t	PID : Selectable PIDF or PIDS	AdrS	Set communication address
o-F.t	Selectable heat-function or cool-function	LoC	The data cannot be changed when the lock key is ON
Uni t	Temperature unit: °C or °F		
H-SC	Set high-limit scale value(Include analog output)		
L-SC	Set low-limit scale value(Include analog output)		

※ It will start to flash by pressing **◀** (◀) key then select each mode by **▲** (▲), **▼** (▼) keys.

After that if press **MD** key, the DATA will be changed then display next mode.

※ It returns to RUN status in case of pressing **MD** key for 3 sec. after setting all mode to change.

※ If no key is touched for 60sec. in each mode, it will return to RUN mode automatically.

※ AL 1, AL 2, LbA, I, d, t, HyS, rEST, rAPU, rAPd modes are not displayed depending on the result of setting group 1. 2 and then jump to next mode.

※ "(★1)" is displayed only when input Sensor/Voltage/Current switch is voltage or current.

※ "(★2)" is displayed only for model with High/Low-limit of transmission output.

Factory defaults(Setting group 2)

Mode	Setting value	Mode	Setting value	Mode	Setting value	Mode	Setting value
In-t	YCAH	AL-t	AL-A	Pi d.t	Pi d.S	H-SC	1300
EU-1	AL-1	Ae.t	tun1	o-F.t	HEAT	L-SC	-100
EU-2	AL-2	rAnP	OFF	Uni t	°C	LoC	OFF







(A) Counter
(B) Timer
(C) Temp. controller
(D) Power controller
(E) Panel meter
(F) Tacho/Speed/Pulse meter
(G) Display unit
(H) Sensor controller
(I) Switching power supply
(J) Proximity sensor
(K) Photo electric sensor
(L) Pressure sensor
(M) Rotary encoder
(N) Stepping motor & Driver & Controller
(O) Graphic panel
(P) Production stoppage models & replacement

TZN/TZ Series

Input range for the sensor

Input sensor		Display	Selectable temperature range(°C)	Selectable temperature range(°F)	
Thermocouple	K(CA) H	℄CAH	-100~1300°C	-148~2372°F	
	K(CA) L	℄CAL	-100.0~999.9°C	This mode cannot be used as °F	
	J(IC) H	JICH	0~800°C	32~1472°F	
	J(IC) L	JICL	0.0~800.0°C	This mode cannot be used as °F	
	R(PR)	r Pr	0~1700°C	32~3092°F	
	E(CR) H	ECr.H	0~800°C	32~1472°F	
	E(CR) L	ECr.L	0.0~800.0°C	This mode cannot be used as °F	
	T(CC) H	tCCH	-200~400°C	-328~752°F	
	T(CC) L	tCCL	-199.9~400.0°C	This mode cannot be used as °F	
	S(PR)	S Pr	0~1700°C	32~3092°F	
	N(NN)	n nn	0~1300°C	32~2372°F	
	W(TT)	U t t	0~2300°C	32~4172°F	
RTD	JIS standard	JPt H	JPt.H	0~500°C	32~932°F
		JPt L	JPt.L	-199.9~199.9°C	-199.9~391.8°F
	DIN standard	DPt H	dPt.H	0~500°C	32~932°F
		DPt L	dPt.L	-199.9~199.9°C	-199.9~391.8°F
Analog input	0-10VDC	A - - 1	-1999~9999°C	-1999~9999°F	
	1-5VDC	A - - 2	-1999~9999°C	-1999~9999°F	
	DC4-20mA	A - - 3	-1999~9999°C	-1999~9999°F	

Selection switch for Input sensor/Voltage/Current

A) In case of thermocouple input <K(CA), J(IC), R(PR), E(CR), T(CC), S(PR), N(NN), W(TT)> In case of RTD input <DPtL, DPtH, JPtL, JPtH >				
S/W1			S/W2	
S/W1:1	1 1	mA V	S/W2:V	
B) In case of voltage input <1-5VDC, 0-10VDC>				
S/W1			S/W2	
S/W1:2	2 2	mA V	S/W2:V	
C) In case of current input <4-20mADC>				
S/W1			S/W2	
S/W1:2	2 2	mA V	S/W2:mA	

※Factory specification of Input sensor/Voltage/Current conversion switch : Temperature sensor input.

※Please select B) or C) according to input specification when it is voltage or current.

Dual PID Auto Tuning Controller

Alarm output function

This unit has output for control and sub(alarm) output. Sub output is optional. (This alarm output is relay contact(1a) and operates regardless of output for control.) Alarm output operates when the temperature of target is getting higher or lower than setting value.

- 1 alarm mode can be selected among 7 kinds of alarm mode at **EV-1(EV-2)** in the setting group 2.
- Since **EV-1** and **EV-2** operate separately, both **EV-1** and **EV-2** cannot be used as a high or low 2nd alarm operation.
- When selecting **LbA** or **SbA** function in **EV-1(EV-2)** of **EV-1**, alarm cannot be operated.
- Please note below "Operation chart for alarm output" & "Option of alarm output" for detailed operation and optional operation.

Operation chart for alarm output

AL-0	—————	No alarm output.
AL-1	<p>OFF ON</p> <p> b</p> <p> △</p> <p> △</p> <p> SV PV</p> <p> 100°C 110°C</p> <p>※When set 10°C in AL 1(AL 2) as deviation temperature</p>	<p>■ Deviation High-limit alarm</p> <p>If deviation between PV and SV is occurring higher than deviation of temperature setting value, the output will be ON. The deviation temperature is set in AL-1 or AL-2 of setting group 1.</p>
AL-2	<p>ON OFF</p> <p> b</p> <p> △</p> <p> △</p> <p> PV SV</p> <p> 90°C 100°C</p> <p>※When set 10°C in AL 1(AL 2) as deviation temperature</p>	<p>■ Deviation Low-limit alarm</p> <p>If deviation between PV and SV is occurring lower than deviation of temperature setting value, the output will be ON. The deviation temperature is set in AL-1 or AL-2 of setting group 1.</p>
AL-3	<p>ON OFF ON</p> <p> b b</p> <p> △ △ △</p> <p> △ △ △</p> <p> PV SV PV</p> <p> 90°C 100°C 110°C</p> <p>※When set 10°C in AL 1(AL 2) as deviation temperature</p>	<p>■ Deviation High/Low-limit alarm</p> <p>If deviation between PV and SV is higher or lower than deviation of temperature setting value, the output will be ON. The deviation temperature is set in AL-1 or AL-2 of setting group 1.</p>
AL-4	<p>OFF ON OFF</p> <p> b b</p> <p> △ △ △</p> <p> △ △ △</p> <p> PV SV PV</p> <p> 90°C 100°C 110°C</p> <p>※When set 10°C in AL 1(AL 2) as deviation temperature</p>	<p>■ Deviation High/Low-limit reverse alarm</p> <p>If deviation between PV and SV is higher or lower than deviation of temperature setting value, the output will be OFF. The deviation temperature is set in AL-1 or AL-2 of setting group 1.</p>
AL-5	<p>OFF ON</p> <p> b</p> <p> △</p> <p> △</p> <p> SV PV</p> <p> 100°C 110°C</p> <p>※When set 110°C in AL 1(AL 2) as alarm temperature</p>	<p>■ The absolute value High-limit alarm</p> <p>If PV is equal or higher than alarm temperature setting value, the output will be ON. The alarm temperature is set in AL-1 or AL-2 of setting group 1.</p>
AL-6	<p>ON OFF</p> <p> b</p> <p> △</p> <p> △</p> <p> PV SV</p> <p> 90°C 100°C</p> <p>※When set 90°C in AL 1(AL 2) as alarm temperature</p>	<p>■ The absolute value Low-limit alarm</p> <p>If PV is equal or lower than alarm temperature setting value, the output will be ON. The alarm temperature is set in AL-1 or AL-2 of setting group 1.</p>

※ "b" is interval between ON and OFF the setting range is 1 ~ 100°C (0.1 ~ 100.0°C) and can be set at "AH45" made in setting group 1.

Alarm setting [AL-t]

Symbol	Operation name	Function
AL-R	General alarm	General alarm output without option.
AL-b	Latch function	When alarm output turns on once, the output will be ON continuously.
AL-C	Standby sequence function	It doesn't output at first operation. (When it reaches to first target value)
AL-d	Latch & Standby sequence function	It operates latch & Standby sequence function together.

(A)
Counter

(B)
Timer

(C)
Temp.
controller

(D)
Power
controller

(E)
Panel
meter

(F)
Tacho/
Speed/
Pulse
meter

(G)
Display
unit

(H)
Sensor
controller

(I)
Switching
power
supply

(J)
Proximity
sensor

(K)
Photo
electric
sensor

(L)
Pressure
sensor

(M)
Rotary
encoder

(N)
Stepping
motor &
Driver &
Controller

(O)
Graphic
panel

(P)
Production
stoppage
models &
replacement

TZN/TZ Series

Function

Auto tuning operation function

PID Auto tuning function automatically measures the thermal characteristics and response of the control system and then executes its value under high response & stability after calculating the time constant of PID required to control optimum temperature.

- Execute the Auto tuning function at initial time after connecting the controller & the sensor.
- Execution of Auto tuning is started when pressing AT key for 3sec. or more.
- When the Auto tuning is started, AT lamp will flash, and when the lamp is OFF, this operation will stop.
- While the Auto tuning function is executing, it is stopped by pressing AT key for 5sec. or more.
- When the power turns off or the stop signal is applied while Auto tuning function is executing, time constant of PID is not changed and it remembers the value before power turns off.
- Time constant of PID selected by Auto tuning function can be changed in setting group 1.
- It has two kinds of Auto tuning mode.

Auto tuning operation is executed at setting value(SV) in Tun1 mode which is factory default. Auto tuning operation is executed at 70% of setting value(SV). Mode change is available in setting group 2.

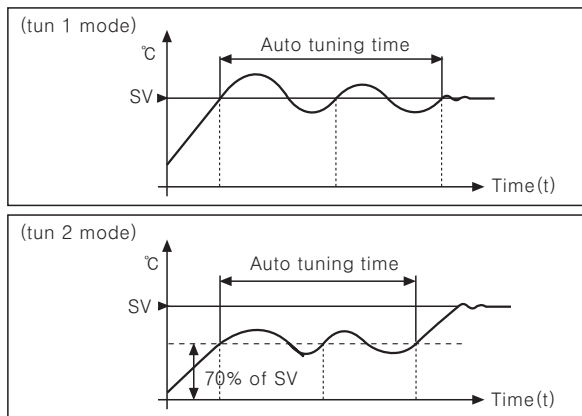

- Execute the Auto tuning function again periodically, because the thermal characteristics for the control object can be changed when the controller is used continuously for a long time.

Sub output(Event) function

Sub output can execute as main control output and sub function as well. There is one sub output in this unit.

- This sub output is relay "1a" contact output.
- 1 mode can be selected among 7 kinds of alarm mode or LBA operated when the heater line is cut, SBA operated when the sensor line is cut.
- The Sub output can be latched ON or automatically reset depending on the alarm option mode selected.
- When the sensor line or the heater line is cut, SBA or LBA output turns on. This "Output on" status must be reset by turning the power off.

Sensor Break Alarm(SBA) function

This function causes the sub output to turn on when the sensor line is cut or open.

It can easy to check that the sensor line is cut or not by operating a buzzer by the relay contact.

- Set SBA mode at Event1 or Event2 mode in setting group 2.

Loop Break Alarm(LBA) function

LBA function is to diagnose an abnormal temperature of the control system. If the temperature of the control system is not changed within $\pm 2^{\circ}\text{C}$ during setting time of LBA, the LBA output will be ON.

Ex) When setting value(SV) is 300°C , process value(PV) is 50°C , this unit controls 100%.

In this time if there is no change of system temperature, it recognizes Heater is cut off then LBA output will be ON.

- LBA output can be selected at EV1 of the setting group 2.
- If LBA output is not selected at event output, it will not be displayed in setting group 1.
- Setting range of LBA output is 1 to 999sec.
- If thermal response of the control system is slow, LBA value should be set to a high value.
- LBA output operates when the manipulated value of the controller is 0% and 100%.
- In case the LBA output is ON, please check the following:
 - ①Short-circuit or cutting of the temp. sensor.
 - ②Abnormal condition of the equipment(Magnet, sub-relay, etc.)
 - ③Abnormal condition of the load(Heater, cooler)
 - ④Wrong-wiring or cutting of the other cables.
- Once SBA is ON due to broken sensor, it will not reset, although sensor is connected. In this case, turn off the power then turn on again.

Error display

If error is occurred while the controller is operating, it will be displayed as follow.

- "LLLL" is flashing when measured input temperature is lower than input range of the sensor.
- "HHHH" is flashing when measured input temperature is higher than input range of the sensor.
- "oPEn" is flashing when the input sensor is not connected or its wire is cut.

Dual PID Auto Tuning Controller

◎ON/OFF control

ON/OFF control is called two position control because the output turns on when PV falls lower than SV and the output turns off when PV is higher than SV. This control method is not only for controlling temperature, but also it is basic control method for sequence control.

- If you set value P as "00" in setting group 1, ON/OFF control will operate.
- There is a programmable temperature difference between ON and OFF in ON/OFF control, if difference is too small, then hunting(chattering) can occur. Temperature difference can be set in HyS position of setting group 1. Setting range is 1 to 100(or 0.1 to 100.0).
- HyS mode is displayed when P value is "00", but HyS will not be displayed, and then jump if P value is not "00".
- This ON/OFF control should not be applied when equipment(Cooling compressor) to be controlled can be damaged by frequent ON and OFF.
- Even if ON/OFF control is stable status, the hunting can be occurred by setting value in HyS or capacity of the heater or response characteristic of the equipment to be controlled or installing position of the sensor. Please consider above points to minimize the hunting when designing the system.

◎Manual reset function

Proportional control has deviation because rising time is not same as falling time, even if the unit operates normally. Manual reset function is used at proportional control mode only.

- If set **rESt** function in setting group 1, the manual reset will run.
- When PV and SV is equal, Reset value is 50.0% and when control is stable, if the temperature is lower than SV, **rESt** value should be higher and on the other hand, reset value should be smaller.
- rESt** setting method according to result of control.

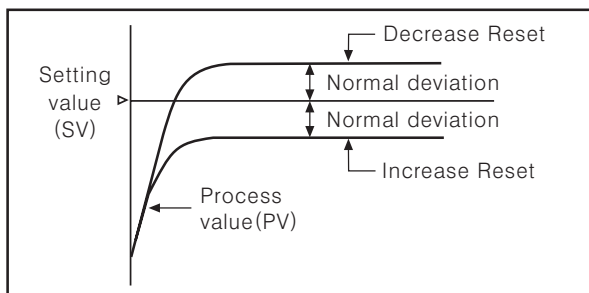

◎Dual PID control function

When controlling temperature, two types of control characteristic are available as below.

One is when you need to minimize the time which PV reaches to SV as like(Fig. 1). The other is when you need to minimize overshoot even though the reaching time(PV to SV) is slow(Fig. 2).

- There are high-speed response type and low-speed response type built in this unit. Therefore user can select each function according to their application.

- You can select dual PID control function in setting group 2. It is selectable **PI dF** or **PI dS** in **PI dt** display.

●PI dF (High-speed response type)

This mode is applied to machines or systems which require high-speed response.

Ex)Machines which must be applied preliminary heat before it operates

※Injection machine, an electric furnace, etc.

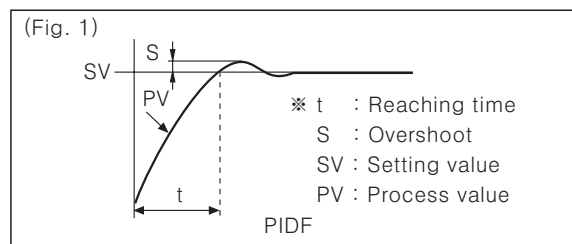

●PI dS (Low-speed response type)

It is PID Slow, used to minimize overshoot even though the response is slow.

For control temperature of oil, plating machine have a possibility of fire with overshoot, **PI dS**(Limit Over) should be used.

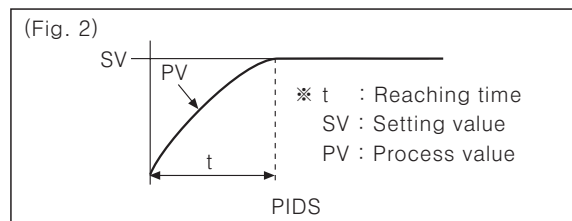

※Factory default setting is **PI dF**.

Please select mode according to control system.

◎RS485 communication function

It is used on the purpose that transmitting PV to an external equipment, setting SV at the external equipment.

- It can be set at bps, Adrs in second setting group
- Communication speed setting : 2400, 4800, 9600bps (Start bit1, Stop bit1, Non parity)
- Adrs setting : 1 ~ 99
- If the external equipment is a PC(Personal Computer) using Converter(SCM-38I) sold separately.

◎Decimal point(Dot) setting function

Decimal point is displayed as "dot" in second setting group when the input is analog only. (0-10VDC, 1-5VDC, DC4-20mA)

(A) Counter

(B) Timer

(C) Temp. controller

(D) Power controller

(E) Panel meter

(F) Tacho/Speed/Pulse meter

(G) Display unit

(H) Sensor controller

(I) Switching power supply

(J) Proximity sensor

(K) Photo electric sensor

(L) Pressure sensor

(M) Rotary encoder

(N) Stepping motor & Driver & Controller

(O) Graphic panel

(P) Production stoppage models & replacement

TZN/TZ Series

◎Cool/Heat function

Generally there are two ways to control temperature, one(Heat-function) is to heat when PV is getting down(Heater). The other(Cool-function) is to cool when PV is getting higher(Freezer).

These functions are operating oppositely when it is ON/OFF control or proportional control.

But in this case PID time constant will be different due to PID time constant will be decided according to control system when it is PID control.

- Cool-function and heat-function can be set at "Setting group 2".
- Cool-function and heat-function must be set correctly according to the application, if set as opposite function, it may cause a fire.
(If set cool-function at heater, even if temperature is getting high, it will be maintained ON and it may cause a fire.)
- Avoid changing heat-function to cool-function or cool-function to heat-function on the unit is operating.
- It is impossible to operate both function at once in this unit. Therefore, only one function should be selected only.
- Factory default setting is heat-function.

◎SV-2 function

If using SV-2 function, it changes the temperature of control system to the second setting value by external relay contact signal. It can change the setting value as sequentially by relay contact without key operation.

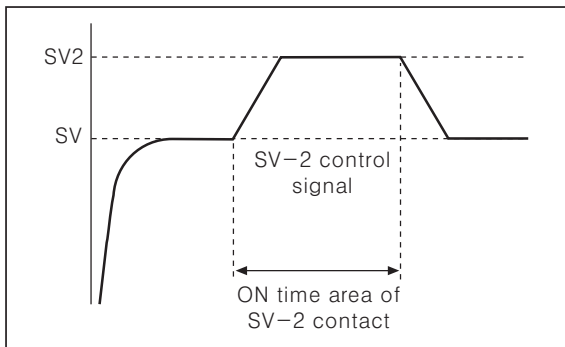

- It can set SV-2 at required time and particular area as like the above chart.
- SV-2 is in setting group 1.
- Application :
The control system, which has to maintain constant temperature such as oven. If you open the door, temperature will go down.
In this case, if you set the second setting value higher than setting value, temperature will rise fast. Therefore, after installing a micro-switch in order to detect the door Open/Close and connect it to SV-2(the second setting value should be higher than SV) then it controls temperature of oven efficiently.

◎Ramp function

Ramp function is to delay the rising time or falling time of temperature. If you change setting value at stable state of control, it forces to rise or fall the temperature of control system during setting time at rAPU, rAPd in setting group 1.

If rAmp is not ON in setting group 2, rAPu, rAPd will not be displayed in setting group 1.

- Set rAmp is ON in setting group 2 for using Ramp function.
- Set the rising time and falling time at **rAPU** mode and **rAPd** mode of setting group 1.
- Ramp function will be operating when changing the set value at stable control status or supply the power again after the power was removed.
- The setting range of rising and falling time is 1~99 minute.

※rAPU function(Delay of rising time)

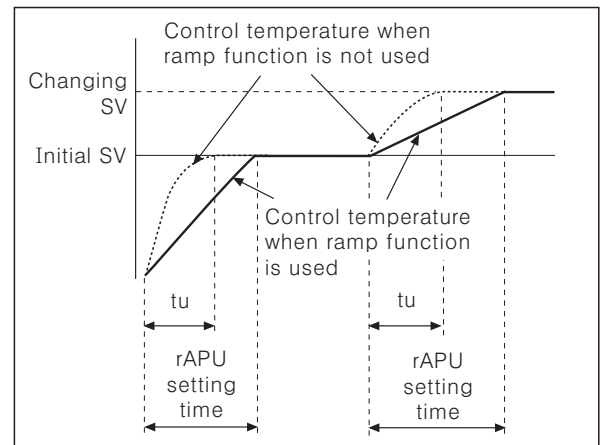

It makes delay rising temperature when change the set value at stable control status or delay the initial rising temperature as like above picture.

Note) **rAPU** time cannot be shorter than rising time (t_u) of temperature when Ramp function is not used.

※rAPd function(Delay of falling time)

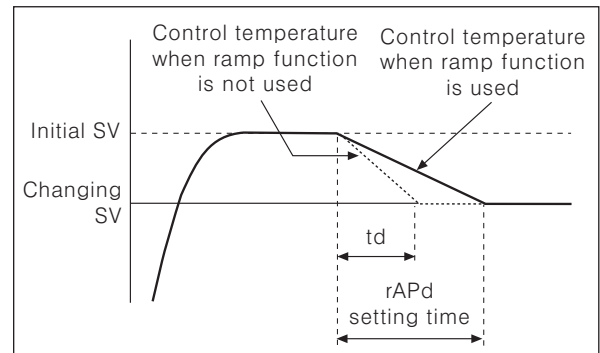

It controls falling temperature as like above.

Note) **rAPd** time cannot be shorter than falling time (t_d) of temperature when Ramp function is not used.

Dual PID Auto Tuning Controller

◎Input correction(In-b) function

Input correction is to correct deviation occurred from temperature sensor such as thermocouples, RTD, Analogue sensor etc. If you check the deviation of every temperature sensor precisely, it can measure temperature accurately.

- Input revise can be set at "I n-b" mode in setting group 1.
- Use this mode after measuring deviation occurred from temperature sensor exactly.
Because if measured deviation value is not corrected, displayed temperature may be too high or too low.
- Setting range of input revise is $-49 \sim +50^{\circ}\text{C}$ ($-50.0 \sim +50.0^{\circ}\text{C}$)
- When you set the Input revise value, you may need to record it, because it will be useful when performing maintenance.

◎Analog input(A-1, A-2, A-3 mode)

- In case of measuring or controlling humidity & pressure, flux, etc, it uses the proper converter which is converting the measuring value to DC4-20mA or 1-5VDC or 0-10VDC.

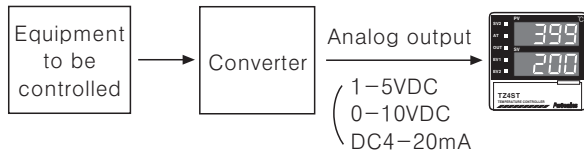

- In order to use the analog output of the converter as the controller input, select the input sensor, voltage/current converter switch built in the controller to be a same condition with analog output.
(This should be operated in power-off status.)
- This unit has the mode for the converter built-in. Please select A-1(0-10VDC) or A-2(1-5VDC) or A-3(DC4-20mA) in selection mode of input in second setting group.
- Set the input value by High scale(H-SC) and Low scale(L-SC) mode.
- Please connect the analog output of the converter to the temperature sensor terminal of the controller. Please be cautious of the polarity.
- After the procedure, it is controlled same with temperature control.
- Ex) After the procedure, it is controlled same with temperature control.

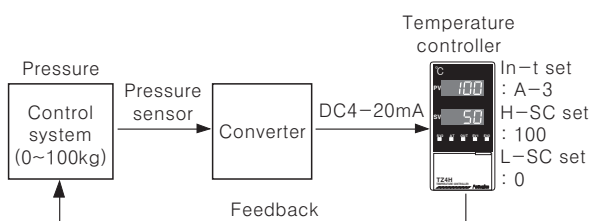

◎Output connections

- Application of relay output type

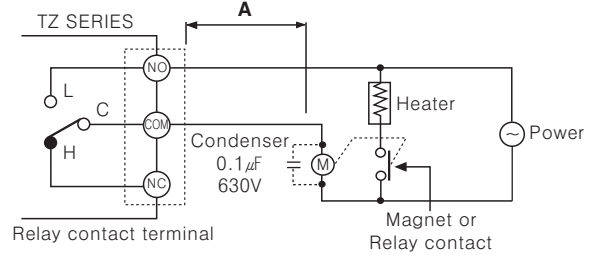

Keep power relay as far away as possible from TZ/TZN series. If wires length of **A** is short, electromotive force occurred from a coil of magnet switch & power relay may flow in power line of the unit, it may cause malfunction. If wires length of **A** is short, please connect a mylar condenser 104(630V) across coil of the power relay "M" to protect electromotive force.

- Application of SSR output type

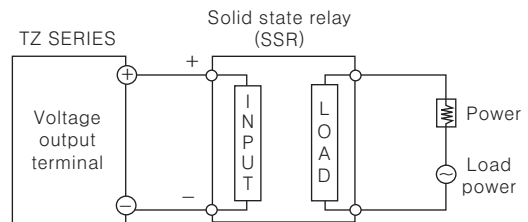

※SSR should be selected by the capacity of load, otherwise, it may short-circuit and result in a fire. Indirect heated should be used with SSR for efficient working.

※Please use a cooling plate or it may cause the capability deterioration, breakdown of SSR for a long usage.

- Application of current output(DC4-20mA)

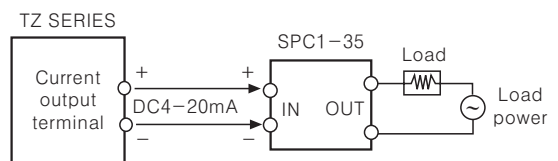

※It is important to select SCR unit after checking the capacity of the load.

※If the capacity is exceeded, it may cause a fire.

- Application of transmission output(DC4-20mA)

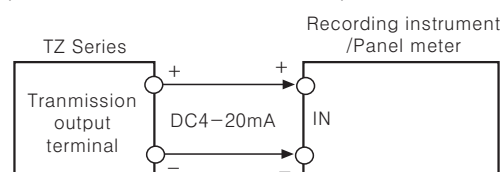

- Application of communication output(RS485)

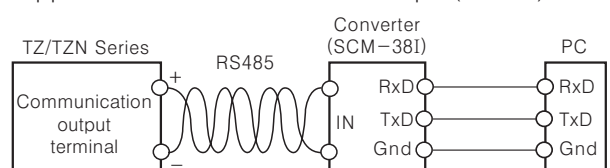

(A)	Counter
(B)	Timer
(C)	Temp. controller
(D)	Power controller
(E)	Panel meter
(F)	Tacho/Speed/Pulse meter
(G)	Display unit
(H)	Sensor controller
(I)	Switching power supply
(J)	Proximity sensor
(K)	Photo electric sensor
(L)	Pressure sensor
(M)	Rotary encoder
(N)	Stepping motor & Driver & Controller
(O)	Graphic panel
(P)	Production stoppage models & replacement

TZN/TZ Series

Communication output

Interface

Standard	EIA RS485
Number of connections	32, It is available to set address 01~99.
Communication method	2 wire half duplex
Synchronous method	Asynchronous type
Communication distance	Within 1.2km
Communication speed	2400, 4800, 9600(Available to set)
Start bit	1bit(Fixed)
Stop bit	1bit(Fixed)
Parity bit	None
Data bit	8bit(Fixed)
Protocol	BCC

System ordering

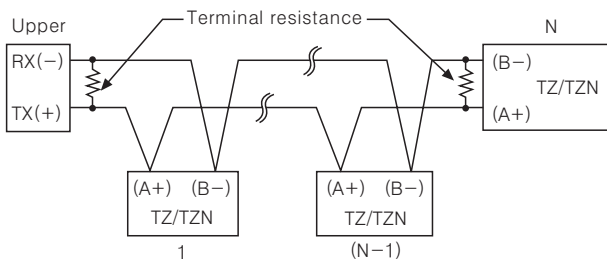

Communication control ordering

- The communication control ordering of TZ/TZN series is exclusive protocol.
- After 4sec. being supplied the power into upper system, then able to start communicating.
- Initial communication will be started by upper system. When Command signal comes out from upper system then TZ/TZN series will respond.

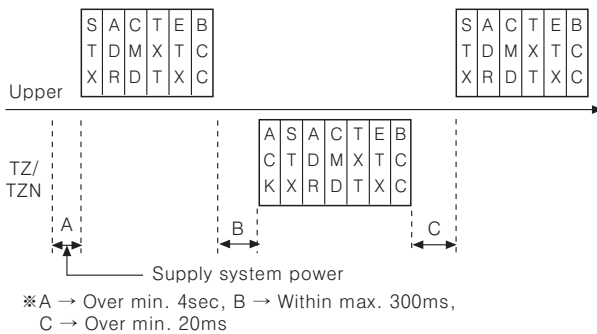

Communication Command and Block

Format of Command and Response

STX	10 ³	10 ²	R/W	X/D		ETX	FSC
Start Code	Address Code	Header Code	Text		END Code	BCC Code	
← Calculation range of Block Check Character →							

① Start code

It indicates the first of Block STX → [02H], in case of response, ACK will be added.

② Address code

This code is upper system can discern TZ/TZN series and able to set within range of 01 to 99. (BCD ASCII)

③ Header code :

It indicates command as 2 alphabets as below.

RX(Read request) → R[52H], X[58H]

RD(Read response) → R[52H], D[44H]

WX(Write request) → W[57H], R[58H]

(Reservation at upper vision of TZ/TZN)

WD(Write response) → W[57H], D[44H]

(Reservation at upper vision of TZ/TZN)

④ Text : It indicates the detail contents of Command /Response. (See command)

⑤ END code :

It indicates the end of Block. ETX → [03H]

⑥ BCC : It indicates XOR operating value from the first to ETX of the protocol as abbreviation of TZ/TZN.

Communication Command

● Read[RX] of measurement/setting value : Address 01, Command RX

1. Command(Upper)

① Command

STX	0	1	R	X	P	0	ETX	FSC
Start	Address		Command head		P:Process value S:Setting value		End	BCC

② Application : Address(01), Header code(RX), Current value(P)

STX	0	1	R	X	P	0	ETX	FSC
02H	30H	31H	52H	58H	50H	30H	03H	BCC

● Write[WX] of setting value : Address 01, Command WX

1. Command(Upper)

① Command

STX	0	1	W	X	S	0	Symbol	10 ³	10 ²	10 ¹	10 ⁰	ETX	FSC
Start	Address		Command head		S:Setting value	Space/-	10 ³	10 ²	10 ¹	10 ⁰	End	BCC	

② Application : Address(01), Head Code(WX) setting value(S) +123

STX	0	1	W	X	S	0	Symbol	10 ³	10 ²	10 ¹	10 ⁰	ETX	FSC
02H	03H	31H	57H	58H	53H	30H	20H	30H	32H	33H	03H	BCC	

Response

● Read of process/Setting value

1. In case of receiving normal process value :

The data is transmitted adding ACK[60H].

(In case process value is +123.4)

A	S	0	1	R	D	P	0	Symbol	10 ³	10 ²	10 ¹	10 ⁰	Decimal point	E	F
C	T	X												X	S
K	X														

A	S	0	1	R	D	P	0	Space	0	1	2	3	1	E	B
C	T	X												X	C
K	X														

06H	02H	30H	31H	52H	44H	50H	30H	20H	30H	31H	32H	33H	31H	03H	B
															C
															C

2. In case process value is -100

A	S	0	1	R	D	P	0	-	0	1	0	0	0	E	B
C	T	X												X	C
K	X														

06H	02H	30H	31H	52H	44H	50H	30H	2DH	30H	31H	30H	30H	30H	03H	B
															C
															C

Dual PID Auto Tuning Controller

●Write of setting value

In case setting value is -100

A	S	0	1	W	D	S	0	Symbol	10 ³	10 ²	10 ¹	10 ⁰	E	F
C	T												T	S
K	X												X	C
A	S	0	1	W	D	S	0	-	0	1	0	0	E	B
C	T												T	C
K	X												X	C
06H	02H	30H	31H	57H	44H	53H	30H	2DH	30H	31H	30H	30H	03H	B
														C
														C

- Others : In case of no response of ACK
 - ①When the address is not the same after receiving STX.
 - ②When receiving buffer overflow is occurred.
 - ③When the baud rate or others communication setting value are not the same.
- When there are no ACK response
 - ①Check the status of lines
 - ②Check the communication condition(Setting value)
 - ③When assuming the problem is due to noise, try to operate communication 3 times more until recovery.
 - ④When occurred communication failure frequently, please adjust the communicating speed.

■Proper usage

○Simple "error" diagnosis

- In case, the load (Heater etc) is not operated, please check operation of the out lamp located in front panel of the unit. If lamp does not operate, please check the parameter of all programmed mode. If lamp is operating, please check the output (Relay, Driving voltage of SSR, DC4-20mA current) after separating output line from the unit. But, the out lamp is not operated for DC4-20mA current output.
- When it displays "Open" during operation. This is a warning that external sensor is cut off. Please turn off power and check the state of sensor. If sensor is not cut off, disconnect sensor line from terminal block and +, - together. When you turn on power it can check room temperature. If this unit cannot indicate room temperature, this unit itself is faulty. Please remove this unit from equipment and service or replace. (When the input mode is thermocouple, it is available to indicate room temperature.)
- In case of indicating "Err-D" in display This Error message is indicated in case of damaging inner chip program data by outer strong noise. In this case, please send the unit to our after service center after removing the unit from system. Noise protection is designed in this unit, but it does not stand up strong noise continuously. If bigger noise than specified(Max. 2kV) flows in the unit, it can be damaged.

■Caution for using

- Please use the terminal(M3.5, Max. 7.2mm) when connecting the AC power source.
- "△" mark indicated on the diagram of this unit means caution-refer to accompanying documents.
- In case of cleaning the unit, please keep as following Cautions;
 - ①Clean dust with a dry tissue.
 - ②Be sure to use alcohol to clean the unit, do not use acid, chromic acid, solvent, etc.
 - ③Be sure to clean the unit after turning off the power and then turn on the power after passing 30minute after cleaning.
- If this unit is used in a manner not to be specified by the manufacture, it can be injury to a person or damage to property.
- Be sure that metal dust and wire-dregs do not flow in the unit, because of malfunction damage of the unit or the cause of a fire.
- Service life for the relay of the unit is indicated in this manual, life cycle is different according to the load capacity and switching times, therefore please use the unit after checking the load capacity and switching times.
- Connect wires correctly after checking polarity of terminals.
- Do not use this unit as following place.
 - ①A place where dust, corrosive gas, oil, moisture are occurred.
 - ②A place where there are high humidity or freezing place.
 - ③A place where sunshine, radiant heat is occurred.
 - ④A place where vibration, shock is occurred.
- If the equipment is used in a manner not specified by the manufacture the protection provided by the equipment may be impaired.
- Please install power switch or circuit-breaker in order to cut power supply off.
- A switch or circuit-breaker meeting the relevant requirements of IEC947-1 and IEC947-3 shall be included in equipment when the temperature controller.
- The switch or circuit-breaker should be installed near by users.
- Do not use this product as Volt-meter or Ampere-meter, this is a temperature controller.
- Installation environment
 - ①It shall be used indoor
 - ②Altitude Max. 2000m
 - ③Pollution Degree 2
 - ④Installation Category II.
- If you want to change the input sensor, reset switches (SW1, SW2) according to each input specification after power off. Turn on power and then set sensor mode by front keys at second flow chart. This SSR and current of this controller are insulate from internal power.
- Do not connect power line to sensor connecting part. The inner circuit may be damaged.

(A) Counter

(B) Timer

(C) Temp. controller

(D) Power controller

(E) Panel meter

(F) Tacho/Speed/Pulse meter

(G) Display unit

(H) Sensor controller

(I) Switching power supply

(J) Proximity sensor

(K) Photo electric sensor

(L) Pressure sensor

(M) Rotary encoder

(N) Stepping motor & Driver & Controller

(O) Graphic panel

(P) Production stoppage models & replacement