

# LE4S Series

## DIN W48 × H48mm Digital backlight LCD Timer

### Features

- Upgraded power supply  
: 24–240VAC 50/60Hz / 24–240VDC
- Internal battery allows memory protection and setting value change
- Wide range of time setting (0.01sec. ~ 9999hour)
- Lock function for saving data
- Various output modes (LE4S:10, LE4SA:7)
- Soft touch setting type
- High visibility LCD display with backlight
- Independent ON/OFF time can be programmed in flicker output mode



**⚠ Please read "Caution for your safety" in operation manual before using.**



### Ordering information

L E 4 S □



	Time limit 1c
A	Time limit 2c, Instantaneous 1c+Time limit 1c(Selectable)
S	DIN W48mm × H48mm
4	9999 (Digit)
E□	Timer
L	LCD Display

### Specifications

Model	LE4S	LE4SA	
Function	Multi time and operation		
Display method	Backlight LCD type (Character size : W4 × H8mm)		
<b>Power supply</b>	24–240VAC 50/60Hz / 24–240VDC		
Allowable voltage range	90 ~ 110% of rated voltage		
Power consumption	Approx. 2.8VA (240VAC 60Hz), Approx. 1.2W (240VDC)		
Reset time	Max. 300ms	Max. 500ms	
Min. input signal	START input	Min. 20ms	
	INHIBIT input		
	RESET input		
Input	START input	● No-voltage input Impedance at short-circuit : Max. 1kΩ Residual voltage : Max. 0.5V Impedance at open-circuit : Min. 100kΩ	
	INHIBIT input		
	RESET input		
Timing operation	Signal ON Start	Power ON Start	
Control output	Contact type	Time limit SPDT (1c)	Time limit DPDT (2c), Time limit SPDT (1c) + Instantaneous SPDT (1c):Selectable
	Contact capacity	250VAC 3A resistive load	
Relay life cycle	Mechanical	Min. 10,000,000 operations	
	Electrical	Min. 100,000 operations at 250VAC 2A resistive load	
Memory protection	10 years at 25°C and when LCD and input key turns OFF, 40 days at 25°C and when LCD and input key turns ON continually		
Output mode	10 kinds of operation mode	7 kinds of operation mode	
Ambient temperature	-10 ~ +55°C (at non-freezing status)		
Storage temperature	-25 ~ +65°C (at non-freezing status)		
Ambient humidity	35 ~ 85%RH		

# Digital LCD Timer

## Specifications

Repeat error	Max. $\pm 0.005\%$ $\pm 0.03\text{sec}$ (Signal Start) Max. $\pm 0.01\%$ $\pm 0.08\text{sec}$ (Power Start)	Max. $\pm 0.01\%$ $\pm 0.05\text{sec}$
SET error		
Voltage error		
Temperature error		
Insulation resistance	Min. 100M $\Omega$ (at 500VDC mega)	
Dielectric strength	2000VAC 50/60Hz for 1 minute	
Noise strength	$\pm 2\text{kV}$ the square wave noise (pulse width:1 $\mu\text{s}$ ) by the noise simulator	
Vibration	Mechanical	0.75mm amplitude at frequency of 10 ~ 55Hz in each of X, Y, Z directions for 1hour
	Malfunction	0.5mm amplitude at frequency of 10 ~ 55Hz in each of X, Y, Z directions for 10 minutes
Shock	Mechanical	300m/s <sup>2</sup> (30G) in X, Y, Z directions for 3 times
	Malfunction	100m/s <sup>2</sup> (10G) in X, Y, Z directions for 3 times
Approval	 	
Unit weight	Approx. 126g	Approx. 130g

## Dimensions

### ●Bracket

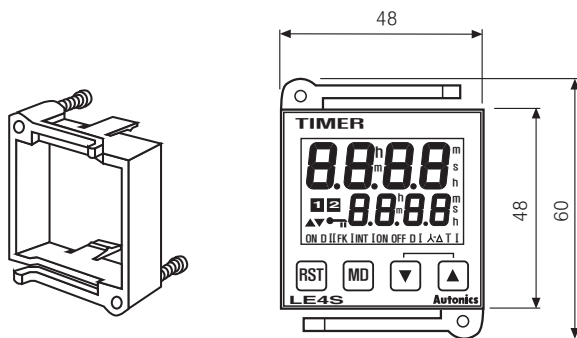

### ●Panel cut-out

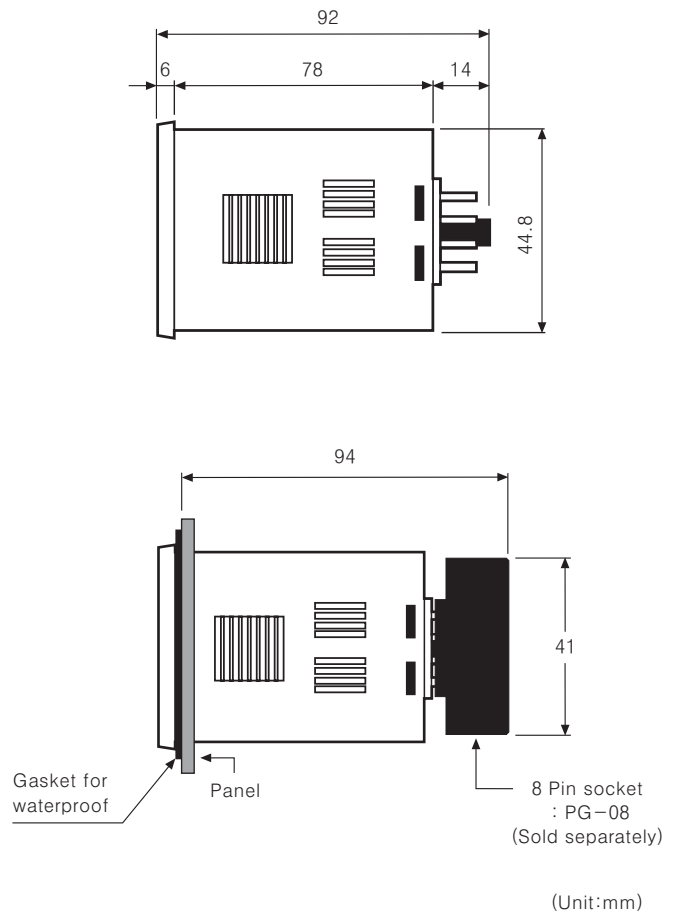
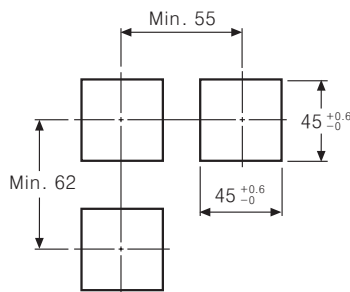

(A) Counter

(B) Timer

(C) Temp. controller

(D) Power controller

(E) Panel meter

(F) Tacho/Speed/Pulse meter

(G) Display unit

(H) Sensor controller

(I) Switching power supply

(J) Proximity sensor

(K) Photo electric sensor

(L) Pressure sensor

(M) Rotary encoder

(N) Stepping motor & Driver & Controller

(O) Graphic panel

(P) Production stoppage models & replacement

# LE4S Series

## Connections

### LE4S

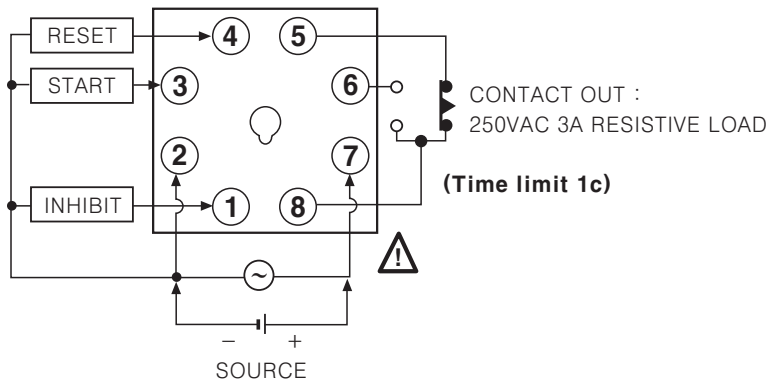

### LE4SA

- [ON.D] [ON.D.II] [FK] [INT] [T] [T.I] mode

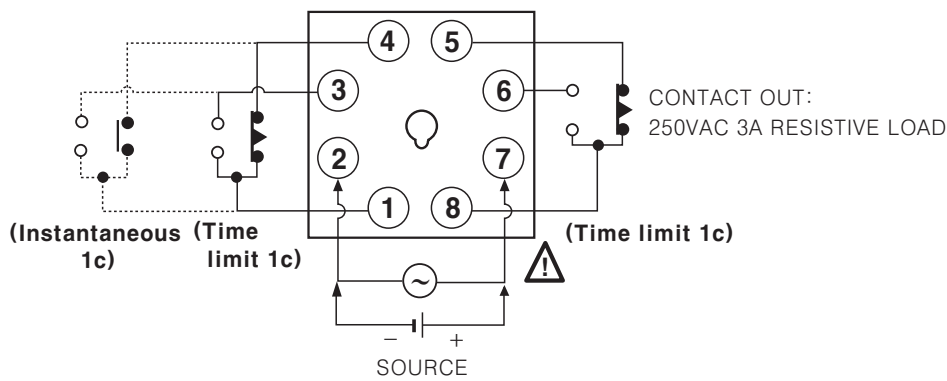

※ [ON.D] [ON.D.II] [FK] [INT] mode : Instantaneous 1c + Time limit 1c, Time limit 2c (Selectable)

※ [T] [T.I] mode : Output contact is fixed as Time limit 2c.

- [λ-Δ] mode

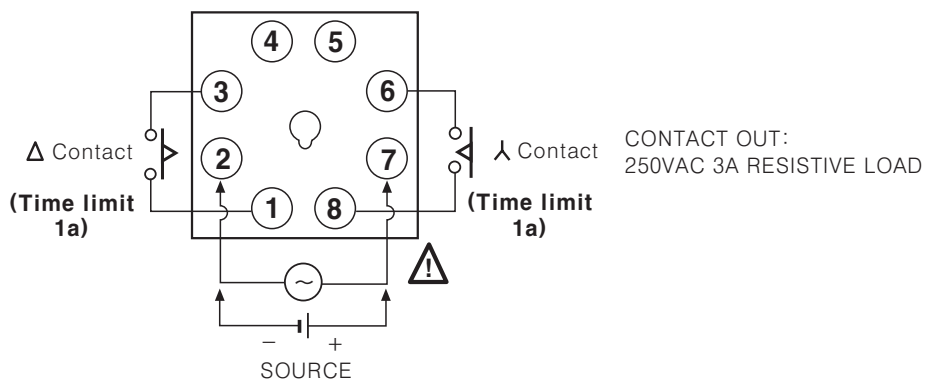

## Input connections

LE4S is No-voltage input (Short-circuit and open) type.

◎ Solid-state input

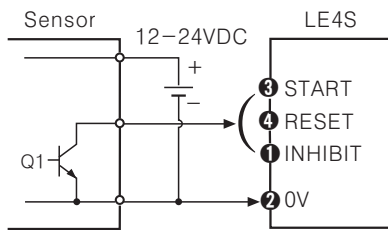

- Q1 is ON : Operating
- Sensor : NPN open collector output
- Short-circuit level (Transistor: ON)  
Residual voltage : Max. 1V,  
Impedance : Max. 1kΩ
- Open-circuit level (Transistor OFF)  
Impedance : Min. 100kΩ

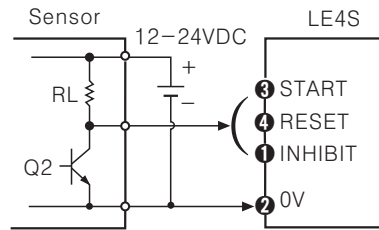

- Q2 is ON : Operating
- Sensor : NPN universal output

◎ Contact input

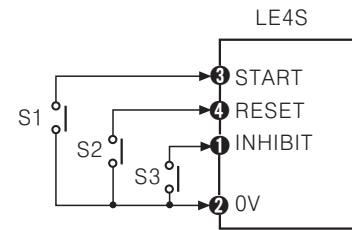

- S1, S2, S3 are ON : Operating
- Please use reliable contact enough to flow 5VDC 1mA.

※ Notice when it is connected since power terminal and signal input terminal are not insulated.

## Front panel identification

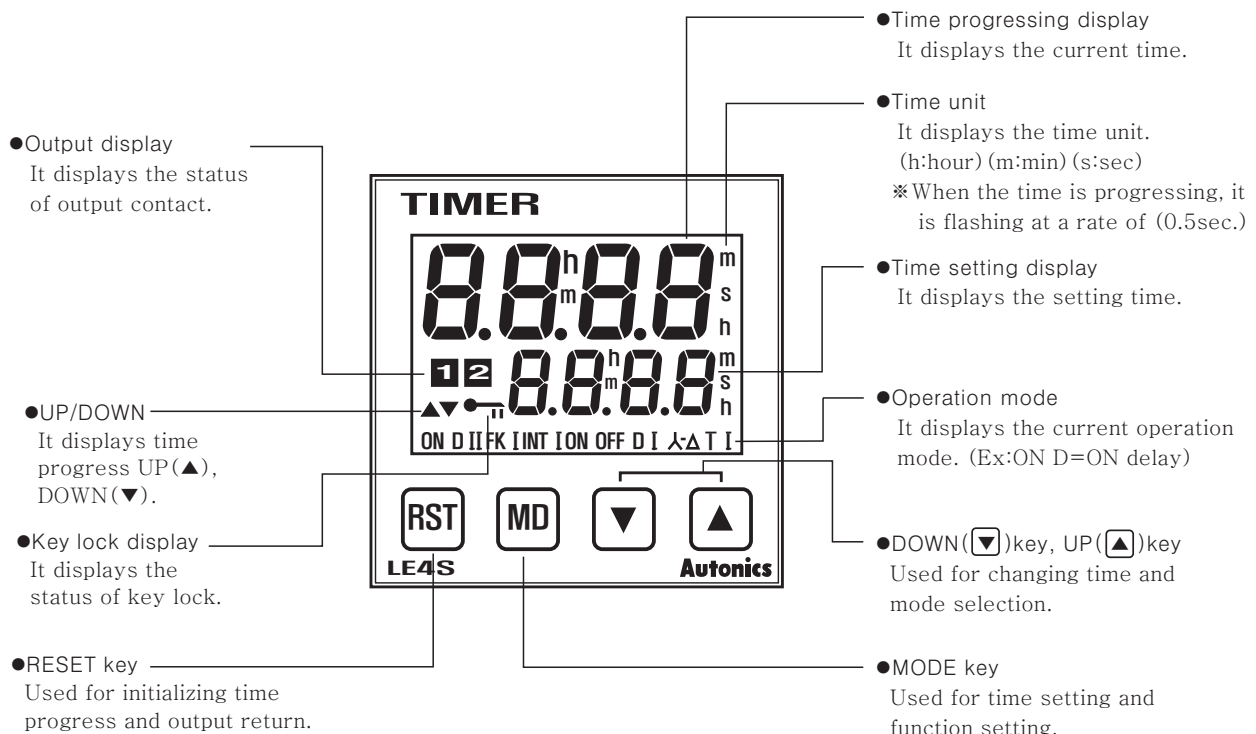

(A) Counter

(B) Timer

(C) Temp. controller

(D) Power controller

(E) Panel meter

(F) Tacho/Speed/Pulse meter

(G) Display unit

(H) Sensor controller

(I) Switching power supply

(J) Proximity sensor

(K) Photo electric sensor

(L) Pressure sensor

(M) Rotary encoder

(N) Stepping motor & Driver & Controller

(O) Graphic panel

(P) Production stoppage models & replacement

# LE4S Series

## ■ Operation flowchart

This is the operation flowchart of **LE4S and LE4SA**. (Refer to B-22~30 for the specific description.)  
 Always program the Timer range, the output operation mode and the setting value in that sequence.  
 Note) If changing the previous output operation mode, the setting value might be deleted.

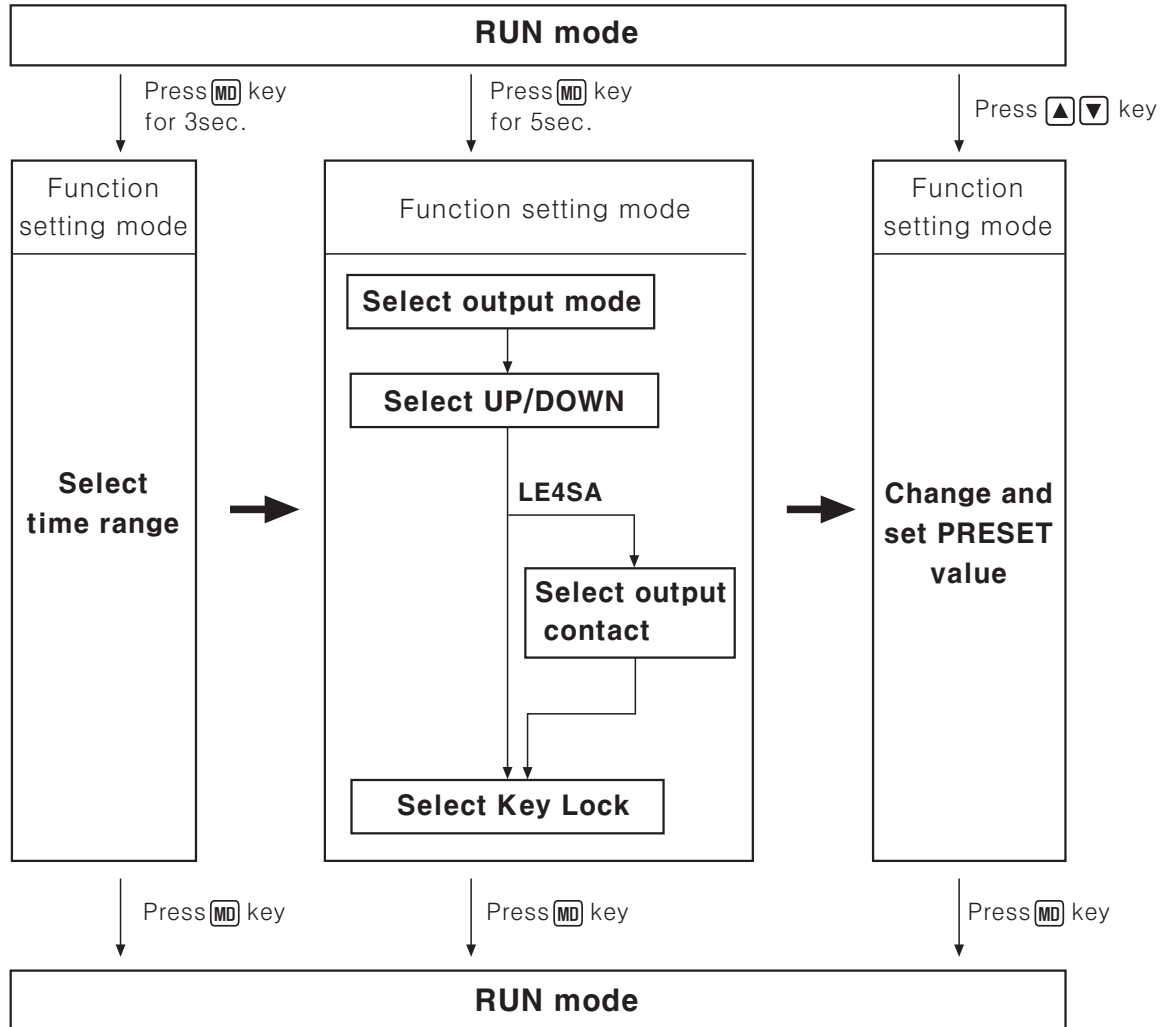

©Factory Default setting

Model	Output mode	Up/Down mode	Output contact	Time range	Key lock
<b>LE4S</b>	ON DELAY	UP	Time limit 1c	99.99sec	LoFF(Lock off)
<b>LE4SA</b>	ON DELAY	UP	Time limit 1c + Instantaneous 1c	99.99sec	Lock1 ([RST] key can not be used.)

## Time specifications (Press **MD** key for 3sec)

### Time range specifications

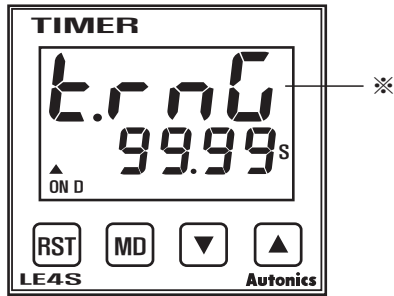

\*t.r.nG is a character of time range mode displayed in LCD. It will be displayed continuously until the selection of time range is completed.

Time range	Time range specification
99.99s	0.01sec ~ 99.99sec
999.9s	0.1sec ~ 999.9sec
9999s	1sec ~ 9999sec
99m59s	1m01sec ~ 99min 59sec
999.9m	0.1min ~ 999.9min
9999m	1min ~ 9999min
99h59m	1h01min ~ 99hour 59min
99.99h	0.01hour ~ 99.99hour
999.9h	0.1hour ~ 999.9hour
9999h	1hour ~ 9999hour

### Time range selection method (Ex : Set 99m 59sec.)

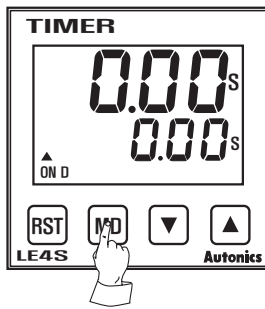

(Fig.1)

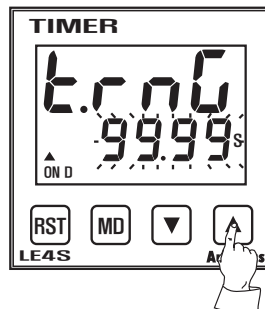

(Fig.2)

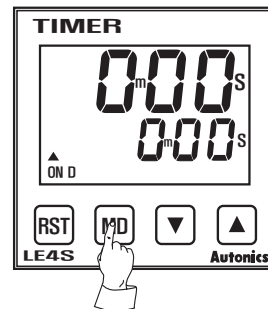

(Fig.3)

- 1) Press **MD** key for 3sec, it advances to time range selection mode. (Fig.1)
- 2) When it advances to time range mode, default value "99.99s" flashes. (Fig.2)
- 3) Select time range as **99m59s** by pressing **▼** and **▲** keys (Press **▲** key 3 times)
- 4) Press **MD** key and Time range selection will be completed and return to RUN mode. (Fig.3)

\*If no keys are touched for 30sec., it will return to RUN mode.

\*Press **MD** key in RUN mode to advance into the function setting mode, output contact specifications are displayed until it goes to the next mode. Press **MD** key to check output contact specifications during the operation, it will return to function setting mode after 3sec.

### Time range flowchart

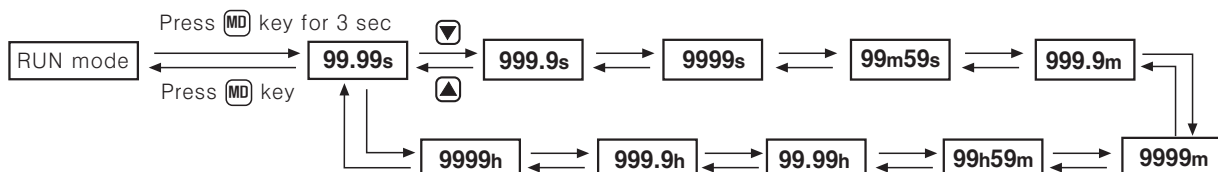

(A) Counter

(B) Timer

(C) Temp. controller

(D) Power controller

(E) Panel meter

(F) Tacho/Speed/Pulse meter

(G) Display unit

(H) Sensor controller

(I) Switching power supply

(J) Proximity sensor

(K) Photo electric sensor

(L) Pressure sensor

(M) Rotary encoder

(N) Stepping motor & Driver & Controller

(O) Graphic panel

(P) Production stoppage models & replacement

# LE4S Series

## Output operation and function (Press **MD** key for 5sec)

● Output operation mode by each model

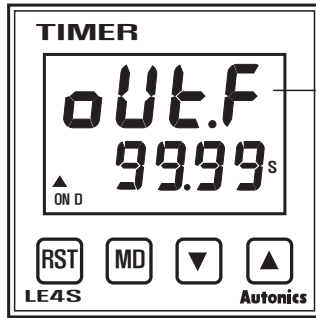

※ "oUt.F" is a character of output mode displayed in LCD. It will be displayed continuously until the selection of output operation is completed.

NO	Display	LE4S	LE4SA	Note
1	<b>ON D</b>	ON DELAY	ON DELAY	
2	<b>ON D I</b>	ON DELAY1	None	
3	<b>ON D II</b>	ON DELAY2(One-shot output)	ON DELAY2	※1
4	<b>FK</b>	FLICKER	FLICKER	※2
5	<b>FK I</b>	FLICKER1	None	
6	<b>INT</b>	INTERVAL-DELAY	INTERVAL-DELAY	
7	<b>INT I</b>	INTERVAL-DELAY1	None	
8	<b>ON OFF D</b>	ON-OFF DELAY	None	
9	<b>ON OFF D I</b>	ON-OFF DELAY1	None	
10	<b>OFF D</b>	OFF DELAY	None	
11	<b>λ-Δ</b>	None	λ-Δ TIMER	
12	<b>T</b>	None	TWIN TIMER	
13	<b>T I</b>	None	TWIN TIMER 1	

(※1) Output of **ON D II** mode is One-shot output and output operation time is fixed as 0.5sec.

(※2) Able to set Ton and Toff time differently in "**FK, FK 1**".

● Output operation

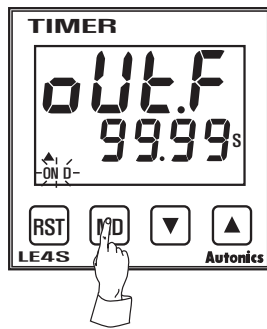

(Fig.1)

- 1) Press **MD** key for 5sec, it advances to output operation selection mode and "ON D" will flash. (Fig.1)
- 2) Press **MD** key after select output operation by **▼** or **▲** keys.
- 3) Press **MD** key, it advances to UP/DOWN selection mode after output operation selection.

※ If no key is touched for 30sec. it will return to RUN mode.

※ Press **MD** key in RUN mode to advance into the function setting mode, output contact specifications are displayed until it goes to the next mode. Press **MD** key to check output contact specifications during the operation, it will return to function setting mode after 3sec.

※ Output operation flowchart

< LE4S >

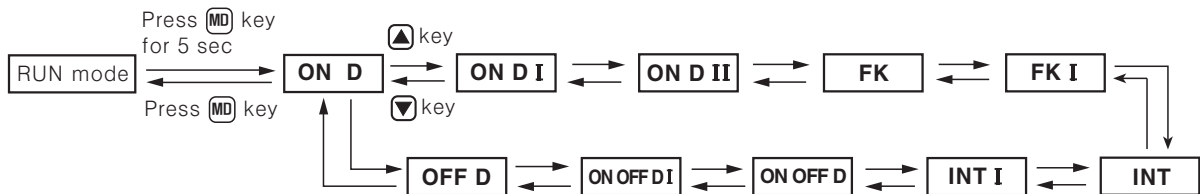

< LE4SA >

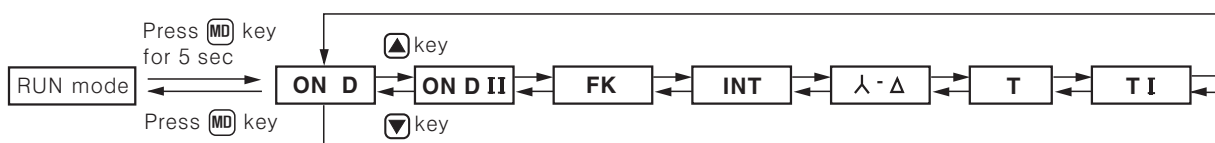

# Digital LCD Timer

## ●UP/DOWN selection

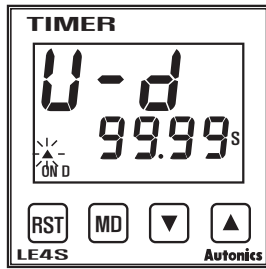

- 1) When it advances to the mode, "U-d" is displayed and "▲" flashes.
- 2) Press **MD** key after select UP or DOWN by ▼ or ▲ keys.

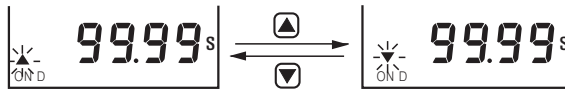

- 3) Press **MD** key, UP/DOWN will be completed then move to key lock(LE4S) mode or move to output contact selection mode(LE4SA).
- ※ "U-d" is a display of UP-DOWN in LCD display, it will be displayed continuously until the selection is completed.
- ※ If no key is touched for 30sec., it will return to RUN mode.

## ●Output contact selection(Available in LE4SA only)

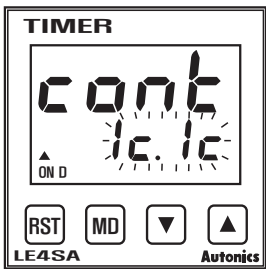

- 1) It displays Instantaneous 1c + Time limit 1c, factory default setting.
- 2) Select proper output contact for output operation mode by ▼ and ▲ key.  
(See LE4SA connections on B-21 for output contact.)

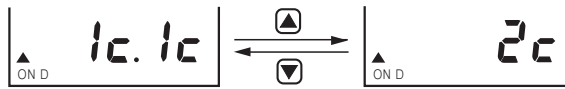

- 3) After selecting output contact then press **MD** key.
  - 4) Press **MD** key, it advances to Key Lock selection mode after select output contact.
- ※ Press **MD** key to check output contact specifications during the operation, it will return to function setting mode after 3sec.
- ※ "cont" is a displayed characteristic of output contact in LCD display. It will be displayed continuously until the selection is completed.
- ※ If no key is touched for 30sec., it will return to RUN mode.

## ●Key Lock selection

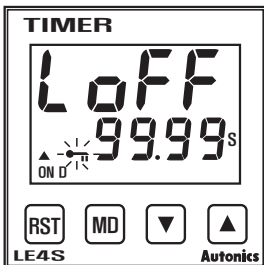

- 1) Factory default setting is Lock OFF.
- 2) Select proper Key Lock function by press ▼ or ▲ keys.

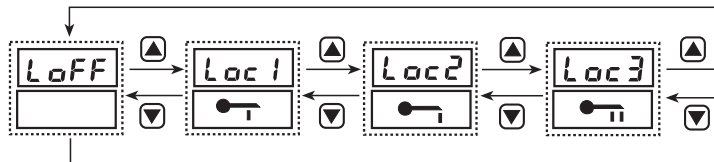

- 3) Press **MD** key to complete key lock selection and then return to RUN mode.
- ※ If no key is touched for 30sec., it will return to RUN mode.

### ※Key Lock function

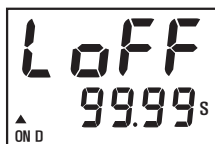

Turns off the Lock mode.

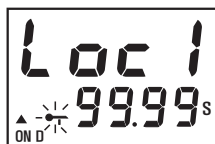

**RST** key cannot be used.

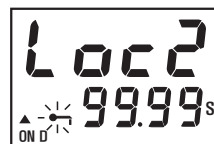

▼, ▲ key cannot be used.



**RST** key, ▼, ▲ key cannot be used.

(A) Counter

(B) Timer

(C) Temp. controller

(D) Power controller

(E) Panel meter

(F) Tacho/Speed/Pulse meter

(G) Display unit

(H) Sensor controller

(I) Switching power supply

(J) Proximity sensor

(K) Photo electric sensor

(L) Pressure sensor

(M) Rotary encoder

(N) Stepping motor & Driver & Controller

(O) Graphic panel

(P) Production stoppage models & replacement



# LE4S Series

## Setting time change

Please set operation time according to following instruction as the setting is different depending on the output operation mode.

### Output operation mode : ON D, ON D I, ON D II, INT, INT I, ON OFF D, ON OFF D I, OFF D

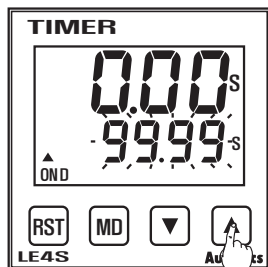

(Fig.1)

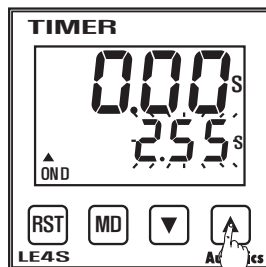

(Fig.2)

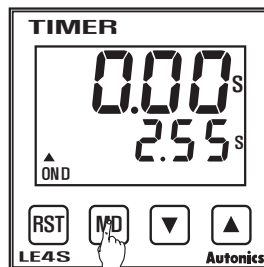

(Fig.3)

- 1) Press  $\downarrow$  or  $\uparrow$  keys in RUN mode, time set digits will flash. (Fig.1)
- 2) Change setting time by press  $\downarrow$  or  $\uparrow$  keys. (Fig.2)
  - As press  $\uparrow$  key ( $\downarrow$  key) once, it will increase (decrease) by 1 digit, number will increase (decrease) faster by press  $\uparrow$  key ( $\downarrow$  key) for over 2sec.
- 3) When the setting is completed, it will be saved and return to RUN mode by pressing  $\text{MD}$  key. (Fig.3)
  - \* Notice time is progressed during the change.
  - \* If the set value is 0, "Err" will be displayed. ("Err" will be removed by pressing  $\downarrow$ ,  $\uparrow$  key)
  - \* If no key is touched for 30sec., it will return to RUN mode.

### Output operation mode : FK, FK I (There is no [FK I] in LE4SA)

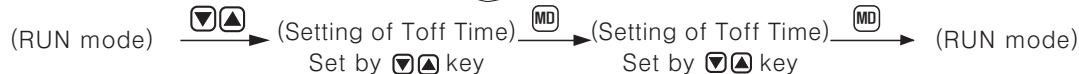
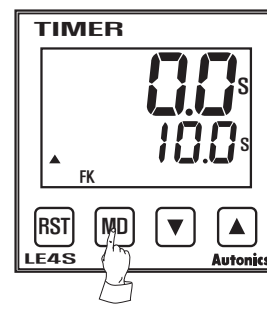
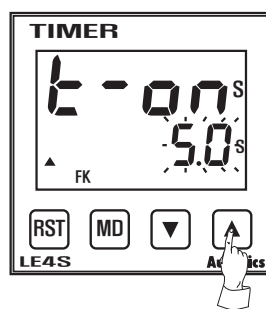
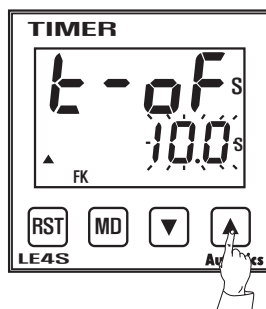
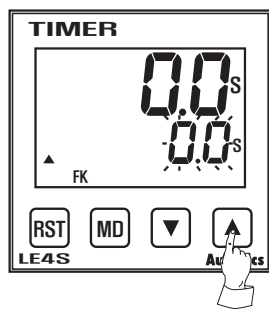

\* Ton and Toff can be set differently.

### Output operation mode : STAR – DELTA ( $\lambda$ - $\Delta$ ) (LE4SA only.)

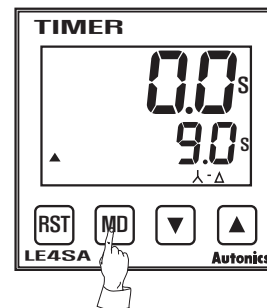
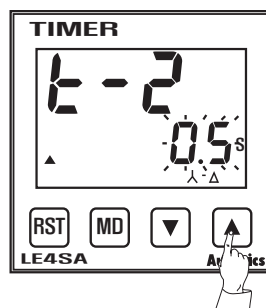
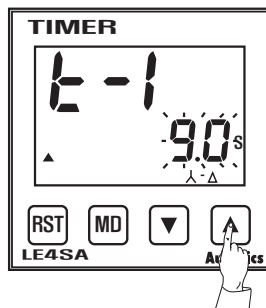
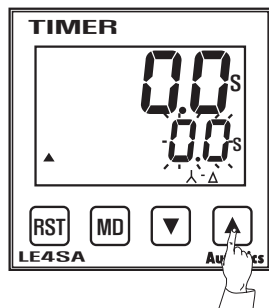

- \* T1 : Setting time, T2 :  $\lambda$ - $\Delta$  switching time
- \* T1 setting time range : 0.1s~9999h, T2 setting time range : 0.05s~9999h
- ☞ If T2 is longer than 0.05sec, "Err" will be displayed.

# Digital LCD Timer

## ●Output operation mode : TWIN TIMER [ T ] (LE4SA only)

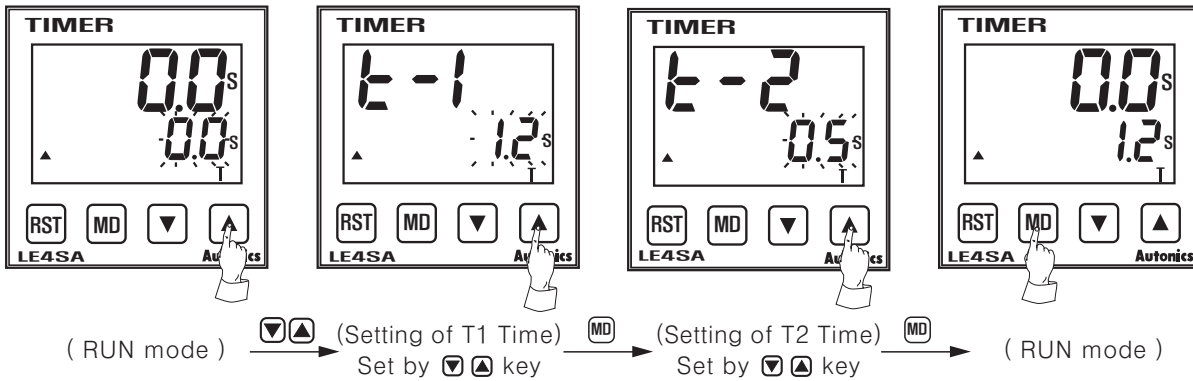

※T1 and T2 can be set as same as differently.

※The setting time range of T1, T2 is within the operation range of the prior time range.

Ex) When 99.99s of time range is selected, the setting range of T1 and T2 are within 0.01~99.99 sec.

## ●Output operation mode : TWIN TIMER( T I ) (LE4SA only)

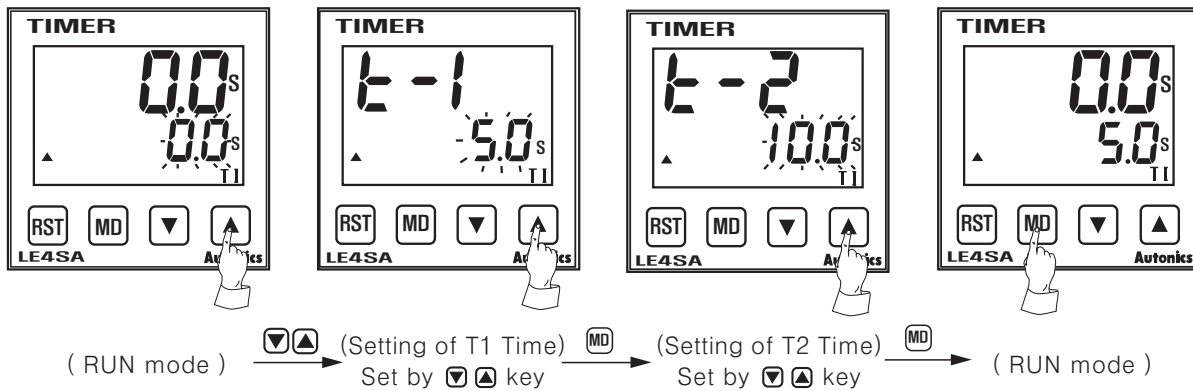

※T1 and T2 can be set as same as differently.

※The setting time range of T1, T2 is within the operation range of the prior time range.

Ex) When 99.99s of time range is selected, the setting range of T1, and T2 are within 0.01~99.99 sec.

(A) Counter

(B) Timer

(C) Temp. controller

(D) Power controller

(E) Panel meter

(F) Tacho/Speed/Pulse meter

(G) Display unit

(H) Sensor controller

(I) Switching power supply

(J) Proximity sensor

(K) Photo electric sensor

(L) Pressure sensor

(M) Rotary encoder

(N) Stepping motor & Driver & Controller

(O) Graphic panel

(P) Production stoppage models & replacement

# LE4S Series

## LE4S Output operation mode

T, Ton, Toff=Setting time

Mode	Time chart	Operation
<b>[ON.D]</b>		
<b>ON-Delay</b>	<p>1. The time progresses when START signal is ON at status of power on.                  2. Output(Relay output) turns on at setting time. (Position ①)                  3. Output and display value will be initialized when RESET signal is ON. (Position ②)                  4. The time will progress when RESET signal is OFF. (Position ③)                  5. When START signal is OFF, time progressing will be initialized and output is returned. (Position ④)</p>	<p>T = Setting time</p>
T > Ta		
<b>[ON.D.I]</b>		
<b>ON-Delay 1</b>	<p>1. The time progresses when START signal is ON, output will be ON at setting time. (Position ①)                  2. Even though the START signal is applied repeatedly, only the initial signal is recognized. (Position ②)                  3. Output and display value will be initialized when RESET signal is ON. (Position ③)                  4. When power ON again after power off, then it will be operating as "STEP1".</p>	<p>T = Setting time</p>
T > Ta		
<b>[ON.D.II]</b>		
<b>ON-Delay 2 (One-shot output)</b>	<p>1. The time progresses when START signal is ON at status of power on.                  2. Output will be ON for 0.5sec(one-shot output) at setting time and then OFF. (Position ①)                  3. If START signal is ON again while time is progressing, the time progressing will be initialized then progress again. (Position ②)</p>	<p>T = Setting time</p>
T > Ta		
<b>[F K]</b>		
<b>Flicker (Precedent operation of Toff)</b>	<p>1. Output will be OFF for Toff time when START signal is ON and then ON status will be held for Ton time and then OFF again.                  2. When RESET signal in ON, processing time and output will be intialized and operate the above procedure again when RESET signal is OFF.                  3. Ton &amp; Toff can be set individually.</p>	<p>Ton, Toff = Setting time</p> <p><b>Able to set Ton and Toff time differently.</b></p>
Ton, Toff > Ta		
<b>[FK.I]</b>		
<b>Flicker 1 (Precedent operation of Ton)</b>	<p>1. Output is ON and OFF repeatedly at setting time when START signal is ON.                  2. Even though the START signal is applied repeatedly, only the initial signal is recognized. (Position ①)                  3. Processing time and output return to initial status when RESET signal is applied and it is started again when START signal is ON.                  4. Toff &amp; Ton can be set individually and Ton time start in [FK.I] mode firstly.</p>	<p>Ton, Toff = Setting time</p> <p><b>Able to set Ton and Toff time differently.</b></p>
Ton, Toff > Ta		

※Initial status : UP mode—display value is "0", output is "OFF".  
 DOWN mode—display value is "setting time", output is "OFF".

## LE4S Time charts(Output mode)

Mode	Time chart	Operation	
<b>[INT]</b>			T=Setting time
<b>Interval-Delay</b>			(A) Counter (B) Timer
T > Ta	<ol style="list-style-type: none"> <li>Output is ON and time processes when START signal is ON during power.</li> <li>When processing time reaches to setting time, the output will be OFF and the display value will be held.</li> <li>Applying reset signal, display value will return to "0" and then start again from number 1. (Position ①)</li> <li>Output and the time return to initial status when START signal is OFF. (② Position)</li> </ol>	T=Setting time	(C) Temp. controller (D) Power controller
<b>[INT. I]</b>			T=Setting time
<b>Interval-Delay 1</b>			(E) Panel meter (F) Tacho/Speed/Pulse meter
T > Ta	<ol style="list-style-type: none"> <li>Output is ON and time processes when START signal is ON during power.</li> <li>When processing time reaches to setting time, the output will be OFF and the display value will be held.</li> <li>Applying reset signal, display value will return to "0" and it is operated when start signal is applied. (Position ②)</li> <li>Even though the START is applied repeatedly, only the initial signal is recognized. (Position ①)</li> </ol>	T=Setting time	(G) Display unit
<b>[ON.OFF.D]</b>			T=Setting time
<b>ON-OFF-Delay</b>			(H) Sensor controller (I) Switching power supply
T > Ta	<ol style="list-style-type: none"> <li>During power is applied, it is repeated as the output is ON when start signal is ON, output is OFF when processing time is equal to setting time, output is ON when start signal is OFF and output is OFF when processing time is equal to setting time.</li> <li>If the START signal is applied repeatedly, the output keeps ON status, progressing time will return to initial status. (Position ①)</li> <li>When the RESET signal turn on, the output and processing time will be initialized and it is operated again when RESET signal is off. (Position ②)</li> </ol>	T=Setting time	(J) Proximity sensor
<b>[ON.OFF.D. I]</b>			T=Setting time
<b>ON-OFF-Delay 1</b>			(K) Photo electric sensor (L) Pressure sensor
T > Ta	<ol style="list-style-type: none"> <li>During power is applied, it is repeated as the output is ON (Position ①) when start signal is ON, output is OFF (Position ②) after progressing time is returned to "0" when start signal is OFF.</li> <li>When the START signal shorter than the setting time, the output will be ON when START signal becomes OFF then the output will be OFF after the setting time. (Position ③)</li> <li>RESET signal is ON, the progressing time and output will return to the initial status.</li> </ol>	T=Setting time	(M) Rotary encoder
<b>[OFF.D]</b>			T=Setting time
<b>OFF-Delay</b>			(N) Stepping motor & Driver & Controller (O) Graphic panel
T > Ta	<ol style="list-style-type: none"> <li>Output is ON when START signal is applied. Timing begins when START signal is off. The output will be OFF after the setting time.</li> <li>RESET signal is ON, the progressing time and output will return to the initial status.</li> </ol>	T=Setting time	(P) Production stoppage models & replacement

\*Initial status : UP mode—display value is "0", output is "OFF".

DOWN mode—display value is "setting time", output is "OFF".

# LE4S Series

## LE4SA Time charts(Output mode)

T, Ton, Toff=Setting time, Rt : Reset time(Min. 200ms)

Mode	Time chart	Operation
<b>[ON.D]</b>		
<b>ON-Delay</b>	<p>1. The time will progress when the power ON.                  2. Time limit contact will be ON, when the progressing time reaches to the setting time at the Time limit 2c output mode. Time limit contact will be ON, when the progressing time reaches to the setting time and instantaneous contact will be ON supplying power at the Time limit 1c + instantaneous 1c output mode.                  3. When apply the RESET signal, Time limit and display value will be initialized only.                  4. When the power is cut off, Time limit contact, Instantaneous contact, display value will be initialized.</p>	<p>T=Setting time</p>
<b>[ON.D. II]</b>		
<b>ON-Delay 2 (One-shot output)</b>	<p>1. The time will progress when the power ON.                  2. When set Time limit contact 2c output mode, Time-limit contact will be ON at the setting time for 0.5sec, then OFF after one-shot output(One-shot output). Time limit contact will be ON at the setting time for 0.5sec and returned and instantaneous contact will be ON supplying power.                  3. When the power is cut off, Instantaneous contact, display value will be initialized.                  When apply the RESET signal, display value will be initialized only.</p>	<p>T=Setting time</p>
<b>[F K]</b>		
<b>Flicker (Precedent operation of Toff)</b>	<p>1. The time will progress when the power ON.                  2. When set Time limit contact 2c, Time limit contact will be ON during setting time of Ton and it is ON during setting time of Ton for Time limit and it is ON supplying power for instantaneous contact when selecting Time limit 1c + instantaneous 1c output mode.                  3. When apply the RESET signal, time limit contact and processing time will be initialized, when the power is cut off, time limit, instantaneous contact, and processing time will be initialized.</p>	<p>Ton, Toff=Setting time</p> <p><b>Able to set T-ON and T-OFF time differently.</b></p>
<b>[INT]</b>		
<b>Interval-Delay</b>	<p>1. The time will progress when the power ON.                  2. When set Time limit contact 2c, Time limit contact will be ON supplying power and it will be OFF after the setting time. When set Time limit contact 1c + instantaneous 1c, Time limit contact will be ON supplying power and it will be OFF after setting time and instantaneous contact is ON when supplying power.                  3. When the power is cut off, Time limit contact, Instantaneous contact and processing time will be initialized. When apply RESET signal, Time limit and processing time will be initialized.</p>	<p>T=Setting time</p>

- \* Initial status : UP mode—display value is "0", output is "OFF".  
 DOWN mode—display value is "setting time", output is "OFF".
- \* Instantaneous contact(OUT2) will be returned when power is off.
- \* RESET key is locked for default set and release the lock to use.

## LE4SA Time charts(Output mode)

Rt : Reset time(Min. 200ms)

Mode	Time chart	Operation				
<b>λ - Δ</b>  <b>STAR-DELTA</b> (Output will be set automatically as Time limit 2c)	<p>1. When the power on, λ contact will be ON then OFF after the setting time(T1). And Δ contact will be ON after switching time(T2).                      2. When cutting the power off or apply the RESET signal, λ-Δ contact will be OFF then display value will be initialized. And it will be run again when the power on or RESET signal is OFF.                      3. If set T2(λ-Δ changeover time) less than 0.05sec., "Err" will be displayed.</p> <table border="1"> <tr> <td>T1 Setting time</td> <td>T2(λ-Δ) Switching time</td> </tr> <tr> <td>0.01s ~ 9999h</td> <td>0.05s ~ 9999h</td> </tr> </table>	T1 Setting time	T2(λ-Δ) Switching time	0.01s ~ 9999h	0.05s ~ 9999h	<p>                     *T1 : Setting time                      T2 : Return time                      (λ - Δ Return time)                 </p>
T1 Setting time	T2(λ-Δ) Switching time					
0.01s ~ 9999h	0.05s ~ 9999h					
<b>[T]</b>  <b>TWIN TIMER</b> (Output will be set automatically as Time limit 2c)	<p>1. T1 contact will be ON at the power on, then OFF after T1 setting time. T2 contact will be ON at T1 contact is OFF, then T2 contact will be OFF after T2 setting time.                      2. The RESET signal is ON to OFF, it starts again from T, setting time.                      3. When power is cut off, T1, T2 contact and processing time will be initialized and when power is applied, it starts again from T1 setting time.</p>	<p>T1, T2 = Setting time</p> <p><b>Able to set T1 and T2 time differently.</b></p>				
<b>[T. I]</b>  <b>TWIN TIMER 1</b> (Output will be set automatically as Time limit 2c)  T1, T2 > Ta	<p>1. The time will progress when the power is on after it is reached to setting value progressing T1, T1 contact will be ON and T2 begins at this time and T2 contact will be ON when it is reached to setting value.                      2. T1 contact, T2 contact and the progressing time will be initialized during apply power again or RESET signal is ON to OFF.                      3. When power is applied again after cutting off power, it starts again from T1 setting time.</p>	<p>T1, T2 = Setting time</p> <p><b>Able to set T1 and T2 time differently.</b></p>				

- \*Initial status : UP mode—display value is "0", output is "OFF".  
 DOWN mode—display value is "setting time", output is "OFF" .
- \*Instantaneous contact(OUT2) will be returned when power is off.
- \*RESET key is locked for default set and release the lock to use.

- (A) Counter
- (B) Timer
- (C) Temp. controller
- (D) Power controller
- (E) Panel meter
- (F) Tacho/Speed/Pulse meter
- (G) Display unit
- (H) Sensor controller
- (I) Switching power supply
- (J) Proximity sensor
- (K) Photo electric sensor
- (L) Pressure sensor
- (M) Rotary encoder
- (N) Stepping motor & Driver & Controller
- (O) Graphic panel
- (P) Production stoppage models & replacement

# LE4S Series

## ■ Proper usage

### ⚠ Caution

**It may give an electric shock if touch the input signal terminal (Between START, RESET, INHIBIT and terminal ②) when the power is supplied.**

#### ◎ Power connection

- Connect AC power line between (②-⑦) for LE4S, LE4SA AC power type. Be careful of power connection for DC power type. (② ← ⊖, ⑦ ← ⊕)
- LE4S, LE4SA work stably within range of rated power. (If using power line with another high voltage line or energy line in the same conduit, it may cause inductive voltage. Therefore please use separate conduit for power line)

#### ◎ Power start

- Caution for power rising time (100ms) after power on and power falling time (200ms) after power off.

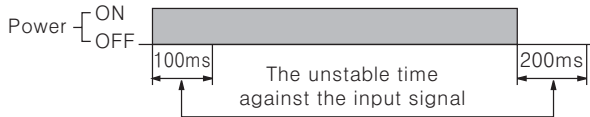

- Power start

LE4SA model is starting after 100ms of applying power (Refer to the above figure.)

(Please use over 100ms setting)

When you need under 100ms setting, please use Signal start type LE4S.

- Please supply power quickly as using switch or relay contact, otherwise it may cause timing error.

#### ◎ Input/Output

- Power terminal and Input terminal have not been insulated because there is no power transformer in this Timer.

① When using the sensor of SSR output type with input terminal of timer, please check whether Double insulated or not.

② Please use double insulated relay when connecting relay output with input terminal.

- Please use 8 Pin socket when connecting this Timer with other equipment and do not touch the socket when power on.

- Please use Power supply with over current protection circuit. (250V 1A fuse)

- When using relay contact as input signal, please use a contact that can function reliable at 5VDC, 1mA.

- In case of connecting START terminal (③) and power terminal (②) of LE4S, do not use it to start at the same time applying power.

Please use relay contact or transistor to start.

(Time error can be occurred under 100ms setting because of rising time of Timer).

- LE4S is Transformer Less type, therefore please check following for connecting relay contact for input signal and transistor.

① When connecting more than 2 Timers with 1 relay contact for input or transistor, please wire following <Fig. 2 >.

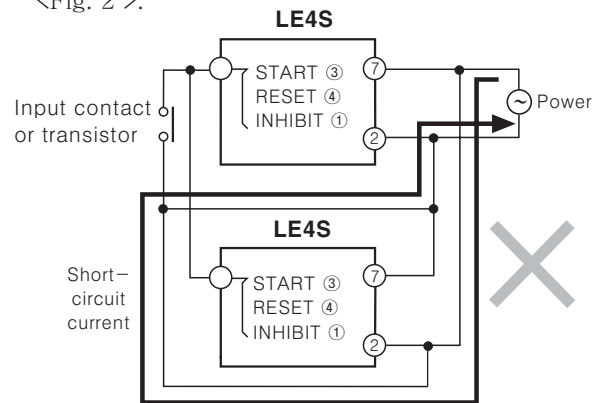

< Fig. 1 >

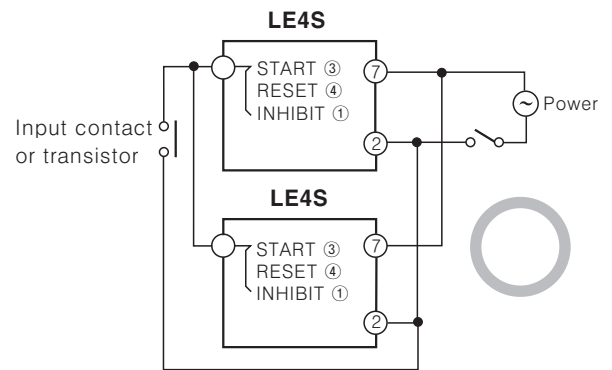

< Fig. 2 >

② Please use transformer with primary and secondary isolated for input.

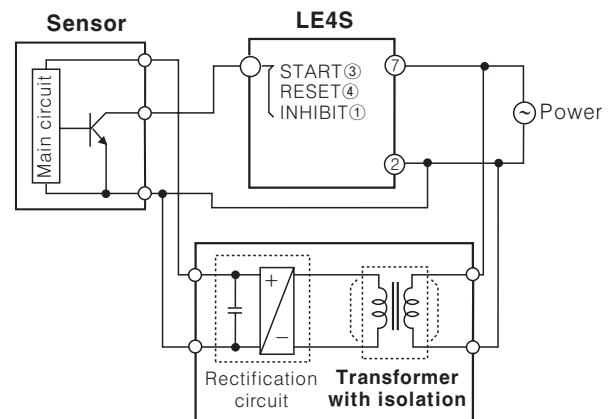

< External sensor power supply >

# Digital LCD Timer

- Please supply power to LE4SA after checking operation specification.
- If setting 「0000」 for operation time, output may not work.

## ◎Interval mode

Able to make Instantaneous ON and Time limit OFF (Holding device) with using interval mode.

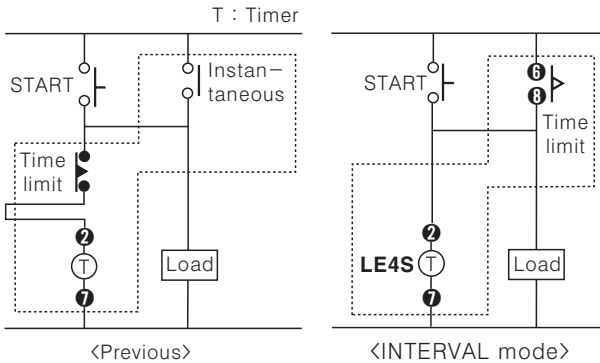

## ◎Change of output operation mode and Timer range

If changing output operation mode or Time range, previous PRESET value will be deleted.

But, Up/Down selection mode and Lock mode are exception.

## ◎Each mode and time setting by internal battery

- It is able to set or change the time setting and function without external power supply because there is a lithium battery built in type, LE4S/LE4SA.
- If pressing any keys on front after purchasing this product, factory specification will be displayed in LCD window. (But, LCD backlight and output are OFF) Time range mode, output operation mode, Up/Down mode, setting time are set in sequence. LCD backlight will be on after setting complete.
- When turning off the power from an external during the operation.
  - ① LCD and output are OFF
  - ② If pressing any key on front, time progressing will be "0".
    - ※ LCD Backlight, input signal and output do not work.
    - ※ If no keys are touched for 30sec after LCD is ON, LCD will be OFF. (Economical in power consumption)
  - ③ At this time, it is able to set or change values of each mode and setting time.
  - ④ When supplying power again, it is changed as ③ and processing time and output will be initialized.

## ◎Change of preset value

- If changing setting value while time progressing, new preset value should be higher than previous preset value. Otherwise output may work while changing setting value.
- If changing setting value while it is running, it will work as changed setting value. Please use LOCK function in order to avoid malfunction.

## ◎Internal battery

- Data will not be lost when power failure because of internal battery.
- Battery life cycle is about 10years(No key operation). This product can work for 40days without external power supply.( 25℃)
- Do not use this product near by fire, there is Lithium battery built in.

## ◎Noise

We test 2kV, pulse width 1 $\mu$ s against Impulse voltage between power terminals and 1kV, Pulse width 1 $\mu$ s at noise simulator against external noise voltage. Please install MP condensor(0.1~1 $\mu$ f) or Oil condensor between power terminals when over IMPULSE noise voltage occurs.

## ◎Environment

Please avoid the following places:

- Where this product may be damaged by strong impact or vibration.
- Where there are corrosive gas or flammable gas and water,oil, dust exist.
- Where magnetic and electrical noise occurs.
- Where there are high temperature and humidity beyond rated specification.
- Where there are strong alkalis and acids.
- Where there are direct rays of sun.

## ◎Mounting

- 1) Insert LE4S, LE4SA into hole on the panel.
- 2) Fix the body by pushing the bracket against the panel.
- 3) Tighten 2 screws in the bracket.

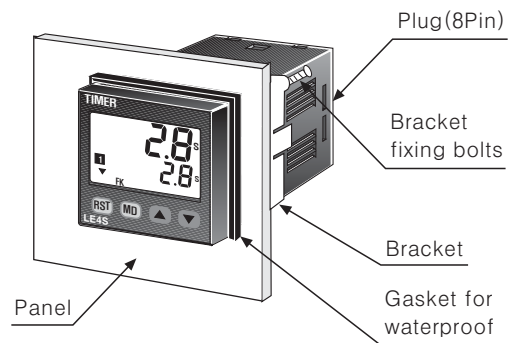

(A) Counter

(B) Timer

(C) Temp. controller

(D) Power controller

(E) Panel meter

(F) Tacho/Speed/Pulse meter

(G) Display unit

(H) Sensor controller

(I) Switching power supply

(J) Proximity sensor

(K) Photo electric sensor

(L) Pressure sensor

(M) Rotary encoder

(N) Stepping motor & Driver & Controller

(O) Graphic panel

(P) Production stoppage models & replacement